



**Berkshire**

ENGINEERED CLEAN

CONTAMINATION CONTROL

**PRODUCT**  
CATALOGUE

CLEANROOMS | ASEPTIC PROCESSING | CONTROLLED ENVIRONMENTS | CLEAN MANUFACTURING



**AEROSPACE & DEFENCE**

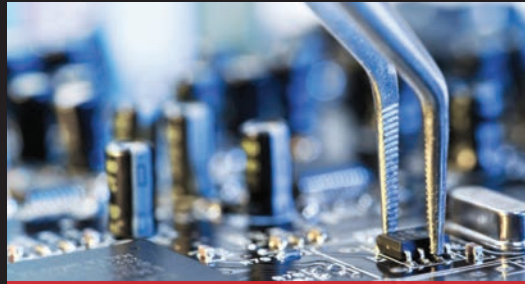

**MICROELECTRONICS**



**AUTOMOTIVE**



**PHARMACEUTICAL/NUTRACEUTICALS**

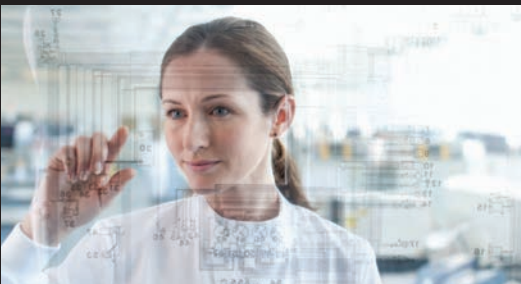

**OPTICS**



**HEALTHCARE**



**PRINT**



**MEDICAL DEVICE**



**UNIVERSITY / RESEARCH**



**FOOD & BEVERAGE**

# TABLE OF CONTENTS

<b>Berkshire Introduction</b>	<b>4</b>
<b>Cleanroom Fundamentals</b>	<b>5</b>
<b>Wiper Test Methods and Substrate Guide</b>	<b>6 - 7</b>
<b>Dry Wipers Selection Guide</b>	
Knitted Wipers	8 - 10
Nonwoven Wipers	11 - 12
Specialty Wipers	13
<b>SatPax® Presaturated Wipers Guide</b>	<b>14 - 16</b>
<b>Sterile and Gamma Irradiated Products</b>	<b>16 - 19</b>
<b>Choice® Products</b>	<b>20 - 24</b>
<b>Pro-Wipe® Industrial Wipers</b>	<b>25</b>
<b>BCR® Documentation Systems</b>	<b>26 - 27</b>
<b>BCR® Glove Liners</b>	<b>28</b>
<b>Lab-Tips® Swabs</b>	<b>29 - 34</b>
<b>Mop Systems &amp; Accessories</b>	<b>35 - 43</b>
<b>BCR® and Choice® Cleanroom Socks</b>	<b>44</b>
<b>Double Bucket System Guide</b>	<b>45</b>

**DID YOU KNOW?**  
This catalogue contains blocks of bonus information throughout.

Explore more tech tips and resources here:



## Europe

E-Mail: [enquiries@berkshire.uk.com](mailto:enquiries@berkshire.uk.com)  
Website: [www.berkshire.uk.com](http://www.berkshire.uk.com)  
[www.berkshire.com.de](http://www.berkshire.com.de)  
[www.berkshiresalleblanche.fr](http://www.berkshiresalleblanche.fr)  
[www.berkshire.com.es](http://www.berkshire.com.es)  
[www.berkshirecamerabianca.it](http://www.berkshirecamerabianca.it)

## North Asia

E-Mail: [master@berkshire.co.jp](mailto:master@berkshire.co.jp)  
Website: [www.berkshire.co.jp](http://www.berkshire.co.jp)

## The Americas

E-Mail: [info@berkshire.com](mailto:info@berkshire.com)  
Website: [www.berkshire.com](http://www.berkshire.com)  
[www.berkshire.mx](http://www.berkshire.mx)

## Southeast Asia

E-mail: [enquiries@berkshire.com.sg](mailto:enquiries@berkshire.com.sg)  
Website: [www.berkshire.com.cn](http://www.berkshire.com.cn)  
[www.berkshire.com.sg](http://www.berkshire.com.sg)



# DRIVING THE TECHNOLOGY OF CONTAMINATION CONTROL

BECAUSE THE SMALLEST MEASURE CAN MAKE THE BIGGEST DIFFERENCE

Berkshire is the global contamination control leader for clean room and controlled environment consumable products. We provide customers with technically advanced materials aimed at application specific performance solutions. For over 50 years Berkshire has understood and delivered world class manufacturing, reliable supply chain, the highest standards of quality, and technically advanced products.



## WHY BERKSHIRE? Engineered Clean

**1** **Quality Programs:**  
ISO9001 Certified  
SPC  
CAPA system  
FMEAs  
IQ, OQ, PQ

Results:  
Superior level of quality, consistency, traceability - the world's cleanest and trusted contamination control products

**2** **How do you determine if your cleanroom supplies are right for your processes?**

Berkshire conducts facility audits that will result in an objective set of observations and recommendations resulting in improved processes and lower TCOO.

**3** **Global Support**



**Documentation**  
Certificates of Sterility  
Certificates of Irradiation  
Certificates of Conformance  
Certificates of Analysis  
Safety Data Sheets  
Product Information Sheets  
Instructional Posters

**People - Training**  
Customer Service Representatives  
Contamination Control Specialists  
Videos  
Chat  
Onsite Support

**4** **Innovation**



# CLEANROOM CONTAMINATION FUNDAMENTALS

WHAT YOU CAN'T SEE CAN HURT YOU

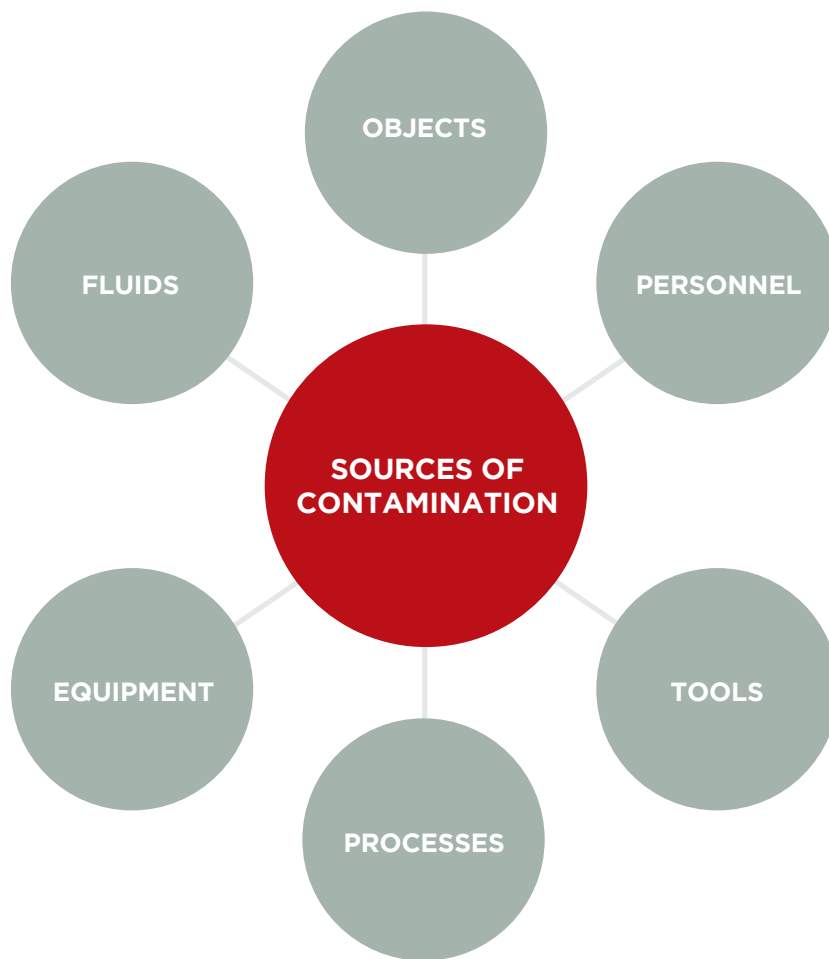

## WHAT CAN YOU DO?

Follow a validated cleaning protocol with written SOPs

Choose and use qualified wipers and other cleanroom cleaning supplies

## INVISIBLE & VISIBLE CONTAMINATION

SKIN PARTICLES

FIBRES

DUST

GREASE

BACTERIA

VIRUSES

METALS

SPORES

NVRS

IONS

FILMS

### REMEMBER

Inappropriate cleanroom supplies can be a source of contamination, not a solution for controlling contamination

# WIPER TEST METHODS

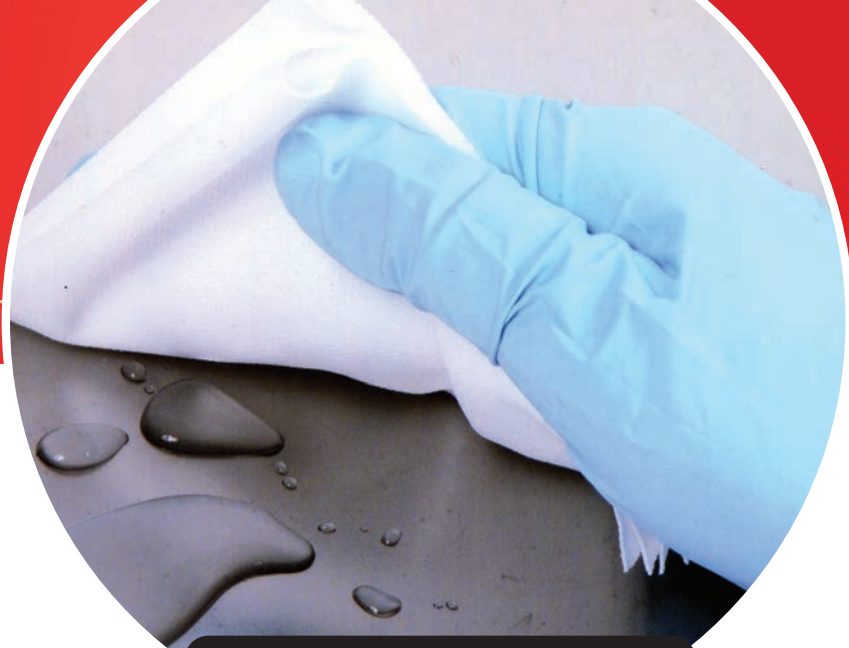

## CLEANLINESS

### Fibres

A wiper is “washed” in water using a biaxial shaker for five minutes. The fibres released into the water are filtered onto a membrane and counted microscopically. The results are expressed as fibres  $\geq 100\mu\text{m}$  per square centimetre of wiper.

(IEST-RP-CC004.3, Section 6.2.2)

### Particle Generation - Biaxial Shake Test/Orbital Shake Test

A wiper is “washed” in water using a biaxial/orbital shaker for five minutes. A liquid-borne particle counter then counts the particles released into the water. By dividing the total number of particles released by the area of the wiper, the results are expressed as particles  $\geq 0.5\mu\text{m}$  per square centimetre of wiper.

(IEST-RP-CC004.3, Section 6.1.3 / IEST-RP-CC004.3, Section 6.1.4)

### Airborne Particle/Helmke Drum Test

Under controlled conditions, ten wipers are tumbled in a rotating drum to release particles from the wiper fabric. An airborne particle counter counts released particles and results are expressed as the number of particles per wiper per cubic foot of air sampled.

(IEST-RP-CC003.4 Section B2.5)

## SORBENCY

### Sorbency

A sample piece of material is saturated with as much fluid as it can hold. After one minute, the material is weighed, and results are expressed in millimetres of fluid per square meter. (IEST-RP-CC004.3, Section 8.1 - modified)

### Efficiency

This calculation indicates how well a material absorbs, relative to others. Results, expressed in millimetres of liquid per gram of material, assist in comparing one raw material with another.

### Rate

This test is a measurement of the time it takes a wiper to absorb a liquid. Results are expressed in seconds. (IEST-RP-CC004.3, Section 8.2 - modified)

## PURITY

### Non-Volatile Residue

Berkshire generates non-volatile data using both deionised water and 2-Propanol. Results are expressed in grams of extractables per square metre of wiper, which is a useful guide to relative purity of wipers. (IEST-RP-CC004.3, Section 7.1.2)

### Metallic Ions

Ions are extracted in deionised water and quantitatively analysed by Ion Chromatography. Results are stated in parts per million (ppm). (IEST-RP-CC004.3, Section 7.2.2)

SKU specific test results can be found on Product Information Sheets located at [Berkshire.com/shop.html](http://Berkshire.com/shop.html)

Attribute		Units	Value	Test Method
Basis Weight		g/m <sup>2</sup>	134	TAPPI T-410
Caliper		$\mu\text{m}$	506	TAPPI T-411
Fibres	$\geq 100\mu\text{m}$	fibres/cm <sup>2</sup>	0.017	IEST-RP-CC004.3, Sec 6.1.3 / Sec 6.2.2
Particles	$\geq 0.5\mu\text{m}$	$\times 10^3/\text{cm}^2$	0.57	IEST-RP-CC004.3, Sec 6.1.4 / Sec 6.2.1
Sorbency	Capacity	mL/m <sup>2</sup>	371	IEST-RP-CC004.3, Sec 8.1 modified /Sec 8.2 modified
	Efficiency	mL/g	2.8	
	Rate	seconds	1	
Non-Volatile Residue	DI Water	g/m <sup>2</sup>	0.0032	IEST-RP-CC004.3, Sec 7.1.2
	IPA	g/m <sup>2</sup>	0.011	
Ions	Na+	ppm	0.0059	IEST-RP-CC004.3, Sec 7.2.2
	K+	ppm	0.00089	
	Ca++	ppm	0.0070	
	Mg++	ppm	0.00013	
	Cl-	ppm	0.011	

# CHOOSE YOUR WIPER SUBSTRATE

**NON-STANDARD OPTIONS AVAILABLE**

new substrate, special size, packaging configuration, and saturation level



## NONWOVENS

### ADVANTAGES

- Natural and synthetic
- Good strength
- More absorbent than knitted
- Very consistent
- Works well with bleaches, quaternary ammonium compounds
- Less expensive than knitted

### CONSIDERATIONS

- Higher levels of fibre and particle contamination
- Poor in abrasive conditions
- Cannot be laundered

### BERKSHIRE OPTIONS

- 55% cellulose/45% polyester
- 100% cotton
- 100% polyester
- 60% cellulose/40% polyester
- 45% cellulose/55% polyester

- 58% polyester/42% lyocell
- 100% polypropylene
- 60% polypropylene/40% cellulose
- 100% microfibre polyester
- 100% polyurethane foam

- 50% rayon/50% polyester
- 63% abaca/37% softwood
- 100% manila hemp
- 70% rayon/30% cellulose



## KNITTED/ LAUNDERED/ SEALED EDGE

### ADVANTAGES

- Tubular/sealed edge means low particle and fibres
- Typically nonabrasive
- Extremely pure
- Durability better than nonwovens
- Absorbent
- Works well with bleaches, quaternary ammonium compounds
- Low NVRs and ionic levels

### CONSIDERATIONS

- Laundered sealed edge wipers are more expensive.
- Not as absorbent as nonwovens

**DID YOU KNOW?**

Nylon microfibre has an incredibly soft hand

### BERKSHIRE OPTIONS

- 100% continuous filament polyester
- 100% polyester microfibre

- 70% polyester/30% nylon microfibre
- 80% polyester/20% nylon microfibre



## KNITTED/ LAUNDERED/ UNSEALED EDGE

### ADVANTAGES

- Particle, fibre levels of laundered knits are lower than nonwovens
- Typically nonabrasive
- Extremely pure
- Durability better than nonwovens
- Absorbent
- Works well with bleaches, quaternary ammonium compounds
- Low NVRs and ionic levels

### CONSIDERATIONS

- Laundered wipers are more expensive
- Higher in fibres than sealed edge version
- Not as absorbent as nonwovens

### BERKSHIRE OPTIONS

- 100% continuous filament polyester

# DRY WIPER SELECTION GUIDE

- 1 EXCELLENT
- 2 GOOD
- 3 FAIR
- 4 NR

## KNITTED WIPERS - LOT TO LOT TRACEABILITY - AUTOCLAVABLE

### ISO CLASS 3-5 | CLEANROOM CLASS 1-100 | EU GRADE B/C/D

PRODUCT/SUBSTRATE	STERILE OPTION	ABSORBENCY	ABRASION RESISTANCE	SENSITIVE SURFACES	LOW-LINTING	SOLVENT COMPATIBLE
<b>CAPSURE®-LP</b> 100% continuous filament polyester		1	1	1	1	1
<b>CAPSURE®-VP</b> 100% continuous filament polyester		1	1	1	1	1
<b>MICROSEAL® 1200</b> 100% continuous filament polyester	•	2	1	1	1	1
<b>MICROSEAL 3000</b> 100% continuous filament polyester		2	1	1	1	1
<b>MICROSEAL SUPERSORB®</b> 100% continuous filament polyester	•	1	1	1	1	1
<b>MICROSEAL® VP</b> 100% continuous filament polyester	•	2	1	1	1	1
<b>SUPER POLX® LWSE</b> 100% continuous filament polyester		2	1	1	1	1
<b>SUPER POLX® SWSE</b> 100% continuous filament polyester		2	1	1	1	1
<b>ULTRA-SEAL® 3000</b> 100% continuous filament polyester	•	1	1	1	1	1
<b>VALUSEAL® 1500</b> 100% continuous filament polyester		2	1	1	1	1
<b>VALUSEAL-HA®</b> 100% continuous filament polyester	•	2	1	1	1	1
<b>VALUSEAL-IONX®</b> 100% continuous filament polyester		2	1	1	1	1
<b>VALUSEAL®-LP</b> 100% continuous filament polyester		2	1	1	1	1

### ISO CLASS 4-5 | CLEANROOM CLASS 10-100 | EU GRADE B/C/D

PRODUCT/SUBSTRATE	STERILE OPTION	ABSORBENCY	ABRASION RESISTANCE	SENSITIVE SURFACES	LOW-LINTING	SOLVENT COMPATIBLE
<b>MICROPOLX® 1100</b> 100% polyester microfibre		2	1	1	1	1
<b>MICROPOLX® 2750</b> 70% polyester/30% nylon microfibre		2	1	1	1	1
<b>MICROPOLX® 2850</b> 70% polyester/30% nylon microfibre		2	1	1	1	1
<b>MICROPOLX® 4000-HP</b> 80% polyester/20% nylon		2	1	1	1	1
<b>SUPER POLX® 1200</b> 100% continuous filament polyester	•	2	1	1	1	1
<b>SUPER POLX® 1200A</b> 100% continuous filament polyester		2	1	1	1	1
<b>SUPER POLX® 1500</b> 100% continuous filament polyester		2	1	1	1	1
<b>SUPER POLX® SW</b> 100% continuous filament polyester		2	1	1	1	1

### ISO CLASS 5-8 | CLEANROOM CLASS 100-100,000 | EU GRADE B/C/D

PRODUCT/SUBSTRATE	STERILE OPTION	ABSORBENCY	ABRASION RESISTANCE	SENSITIVE SURFACES	LOW-LINTING	SOLVENT COMPATIBLE
<b>POLX® 1200</b> 100% continuous filament polyester		2	1	1	2	1



**ISO CLASS 3-5**

CLEANROOM CLASS 1-100 | EU GRADE B/C/D

**CapSure®-LP**

100% continuous filament polyester knit

ValuSeal®-LP wiper with the breakthrough CapSure® patented surface treatment technology

SKU	SIZE	SHEETS/PACK	PACKS/CASE
CPSLP0909.8	23x23cm	150	8

Sealed Edge, Cleanroom Laundered

**CapSure®-VP**

100% continuous filament polyester knit

Lightweight tightly knitted MicroSeal®-VP with the breakthrough CapSure® surface treatment technology

SKU	SIZE	SHEETS/PACK	PACKS/CASE
CPSVP:0909.8	23x23cm	150	8

Sealed Edge, Cleanroom Laundered

**MicroSeal® 1200**

100% continuous filament polyester knit

MicroSeal® 1200 is a highly absorbent versatile general purpose wiper with an excellent hand for cleaning rough surfaces

SKU	SIZE	SHEETS/PACK	PACKS/CASE
MS1200.0404B.10	10x10cm	600 (BULK)	10
MS1200.0909.8	23x23cm	100	8
MS1200.0909B.8	23x23cm	100 (BULK)	8
MS1200.1212.6	30x30cm	100	6

Sealed Edge, Cleanroom Laundered

**MicroSeal SuperSorb®**

100% continuous filament polyester knit

MicroSeal SuperSorb® 2-ply construction diamond pattern make this the most absorbent polyester wiper available. Low endotoxin version available.

SKU	SIZE	SHEETS/PACK	PACKS/CASE
MSSS.0909.8	23x23cm	100	8
MSSS.1212.12	30x30cm	50	12
MSSS09098LE	23x23cm	100	8

Sealed Edge, Cleanroom Laundered

**MicroSeal® 3000**

100% continuous filament polyester knit

MicroSeal 3000 is a highly absorbent versatile general purpose wiper that is chemically compatible with most solvents.

SKU	SIZE	SHEETS/PACK	PACKS/CASE
MS3000.0909.8	23x23cm	100	8

Sealed Edge, Cleanroom Laundered

**MicroSeal®-VP**

100% continuous filament polyester knit

MicroSeal®-VP is a lightweight wiper with a tightly knit material design that reduces the actual cost in use compared to heavier weight products and minimises abrasion of components. Low endotoxin version available.

SKU	SIZE	SHEETS/PACK	PACKS/CASE
MSVP:0909B.8	23x23cm	150 (bulk)	8
MSVP09098LE	23x23cm	150	8
GWVPST0940*	23x23cm	20	40
GWVPST25*	23x23cm	20	25
GWVPST25LE	30x30cm	20	25

Sealed Edge, Cleanroom Laundered

**Super Polx® LWSE**

100% continuous filament polyester knit

Super Polx® LWSE is a lightweight economically bulk packed 4 sided sealed edge wipe.

SKU	SIZE	SHEETS/PACK	PACKS/CASE
SPLWSE0909B14	23x23cm	150 (bulk)	14

Sealed Edge, Cleanroom Laundered

**KNITTED WIPERS - LOT TO LOT TRACEABILITY - AUTOCLAVABLE****Super Polx® SWSE**

100% continuous filament polyester knit

Super Polx® SWSE is a 4 sided sealed edge wipe that soft and pliable edges for sensitive surfaces.

SKU	SIZE	SHEETS/PACK	PACKS/CASE
SPSWSE0404B10	10x10cm	600 (BULK)	10
SPSWSE090910	23x23cm	150	10
SPSWSE0909B10	23x23cm	150 (BULK)	10
SPSWSE121210	30x30cm	150	10

Sealed Edge, Cleanroom Laundered

**Ultra-Seal® 3000**

100% continuous filament polyester knit

Ultra-Seal® 3000 is a 2-ply pinsonic tubular wiper, constructed using a patented sealed edge process resulting in reduced fibre generation and superior absorbency

SKU	SIZE	SHEETS/PACK	PACKS/CASE
US3000.0909.8	23x23cm	100	8
US3000.1212.6	30x30cm	100	6
GW300ST25*	30x30cm	10	25

Sealed Border Edge, Cleanroom Laundered

**ValuSeal® 1500**

100% continuous filament polyester knit

Lightweight, high absorbency material design reduces actual cost in use compared to heavier weight products

SKU	SIZE	SHEETS/PACK	PACKS/CASE
VS1500.0909.8	23x23cm	150	8
VS1500.0909B.8	23x23cm	150 (BULK)	8

Sealed Edge, Cleanroom Laundered

**ValuSeal-HA®**

100% continuous filament polyester knit

Lightweight and absorbent construction with strong tear and abrasion resistance

SKU	SIZE	SHEETS/PACK	PACKS/CASE
VSHA.0909.8	23x23cm	150	8
VSHA.0909B.8	23x23cm	150 (BULK)	8
VSHA.1212.14	30x30cm	75	14
VSHA.1212B.14	30x30cm	75 (BULK)	14
GWHA.ST.10	23x23cm	30	10

Sealed Edge, Cleanroom Laundered

**ValuSeal® IonX®**

100% continuous filament polyester knit

ValuSeal® IonX® is manufactured using a proprietary ISO Class 4 cleanroom laundry process ensuring ultra-low NVR and ionic contamination levels.

SKU	SIZE	SHEETS/PACK	PACKS/CASE
VSI.0708B.14	18x20cm	150 (BULK)	14
VSI.0909.14	23x23cm	150	14

Sealed Edge, Cleanroom Laundered

**ValuSeal® LP**

100% continuous filament polyester knit

Critically low particles, fibres, ions and extractables

SKU	SIZE	SHEETS/PACK	PACKS/CASE
VSLP:0909.8	23x23cm	150	8
VSLP:0909B.8	23x23cm	150 (BULK)	8
VSLP:1212.14	30x30cm	75	14

\* Sterile Version

Gamma irradiated and sterile validated to a 10<sup>-6</sup> Sterility Assurance Level per ANSI/AAMI/ISO guidelines - EU Grade A/B/C/D

## KNITTED WIPERS - LOT TO LOT TRACEABILITY - AUTOCLAVABLE

### ISO CLASS 4-5

CLEANROOM CLASS 10-100 | EU GRADE B/C/D

#### MicroPolx® 1100

100% polyester microfibre

MicroPolx® 1100 has microfibre yarn with 3 times the yarn surface area of standard polyester cleanroom wipers. Its soft smooth surface is suitable for cleaning sensitive or scratch prone surfaces.

SKU	SIZE	SHEETS/PACK	PACKS/CASE
MP1100090914	23x23cm	150	14
MP1100121210	30x30cm	150	10

Sealed Edge, Cleanroom Laundered

#### MicroPolx® 2750

70% polyester/30% nylon microfibre

MicroPolx® 2750 is manufactured with ultrafine microfibre yarn with wedge shaped fiber cross sections that lift, entrap and remove particulates from critical surfaces. Soft hand and non-abrasive ultrasonic sealed edge are excellent for sensitive or scratch prone surfaces.

SKU	SIZE	SHEETS/PACK	PACKS/CASE
MPX2750.0909.10	23x23cm	100	10

Sealed Edge, Cleanroom Laundered

#### MicroPolx® 2850

70% polyester/30% nylon microfibre

MicroPolx® 2850 has 8 times the number of filaments and 4 times the surface area of a standard polyester wipe.

SKU	SIZE	SHEETS/PACK	PACKS/CASE
MPX2850090910	23x23cm	100	10
MPX2850121210	30x30cm	100	10

Sealed Edge, Cleanroom Laundered

#### MicroPolx® 4000-HP

80% polyester/20% nylon microfibre

MicroPolx® 4000-HP removes oily soils with little or no solvent required. It is abrasion resistant.

SKU	SIZE	SHEETS/PACK	PACKS/CASE
MP4000HP060640	15x15cm	25	40
MP4000HP090910	23x23cm	50	10

Sealed Edge, Cleanroom Laundered

#### Super Polx® 1200

100% continuous filament polyester knit

Super Polx® 1200 absorbs three times its own weight and is durable for abrasive wiping.

SKU	SIZE	SHEETS/PACK	PACKS/CASE
S1200.0404.10	10x10cm	600 (BULK)	10
S1200.0909.8	23x23cm	150	8
S1200.0909B.8	23x23cm	150 (BULK)	8
S1200.1212.14	30x30cm	75	14
GW120ST0940*	23x23cm	20	40
GW120ST15*	30x30cm	20	15

Knife Cut, Cleanroom Laundered

#### Super Polx® 1200A

100% continuous filament polyester knit

Super Polx® 1200A is an economical alternative to Super Polx® 1200. Soft hand with very good absorbency.

SKU	SIZE	SHEETS/PACK	PACKS/CASE
S1200A090910	23x23cm	150	10
S12000909B10	23x23cm	150 (BULK)	10
S1200A121210	30x30cm	150	10

Sealed Edge, Cleanroom Laundered

#### Super Polx® SW

100% continuous filament polyester knit

Excellent choice for high volume cleaning and wipe downs. Super Polx® SW is economical, chemically compatible, and abrasion resistant.

SKU	SIZE	SHEETS/PACK	PACKS/CASE
SPSW090910	23x23cm	150	10
SPSW0909B10	23x23cm	150 (BULK)	10
SPSW121210	30x30cm	150	10

Knife Cut, Cleanroom Laundered

German BfR Recommendation XXXVI(June 2017) and EC Regulation 1935 (2004), Contact Compliant.

#### Super Polx® 1500

100% continuous filament polyester knit

Super Polx® 1500 absorbs two times its own weight and is lightweight and economical.

SKU	SIZE	SHEETS/PACK	PACKS/CASE
S1500.0909.8	23x23cm	150	8

Knife Cut, Cleanroom Laundered

### ISO CLASS 5-8

CLEANROOM CLASS 100-100,000 | EU GRADE B/C/D

#### Polx® 1200

100% continuous filament polyester knit

Polx® 1200 bridges the gap between more expensive laundered wipers and lower cost less critical nonwovens.

SKU	SIZE	SHEETS/PACK	PACKS/CASE
P1200.0909.8	23x23cm	150	8
P1200.1212.14	30x30cm	75	14

Knife Cut Edge, Unlaundered

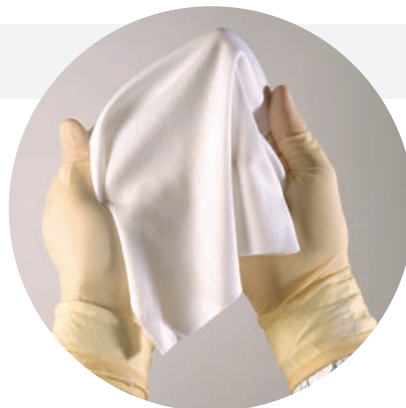

# NONWOVEN WIPERS - LOT TO LOT TRACEABILITY - AUTOCLAVABLE

## ISO CLASS 5-8

CLEANROOM CLASS 100-100,000 | EU GRADE B/C/D

<b>1</b> EXCELLENT	<b>3</b> FAIR
<b>2</b> GOOD	<b>4</b> NR

PRODUCT/SUBSTRATE	STERILE OPTION	ABSORBENCY	ABRASION RESISTANCE	SENSITIVE SURFACES	LOW-LINTING	SOLVENT COMPATIBLE
<b>BLUESORB® 750</b> 55% cellulose/45% polyester		1	2	2	2	2
<b>DURX® 570</b> 55% cellulose/45% polyester		1	2	2	2	2
<b>DURX® 670</b> 55% cellulose/45% polyester	•	1	2	2	2	2
<b>DURX® 770</b> 55% cellulose/45% polyester		1	2	2	2	2
<b>ECOCLEAN® 60</b> 100% cotton		1	2	2	2	2
<b>MICROFIRST®</b> 45% cellulose/55% polyester		1	2	2	2	2
<b>MICROFIRST® LP LOW ENDOTOXIN</b> 58% polyester/42% lyocell	•	1	1	1	2	2
<b>PROJX® 700</b> 55% cellulose/45% polyester		1	2	2	2	2
<b>PRO-WIPE® 750</b> 60% polypropylene/40% cellulose		1	2	1	1	2
<b>PRO-WIPE® 880</b> 100% polypropylene		2	2	1	1	1
<b>VALUCLEAN® PLUS</b> 50% rayon/50% polyester (not autoclavable)		1	2	2	2	2

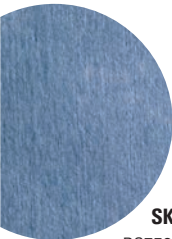

**BlueSorb® 750** 55% cellulose/45% polyester  
BlueSorb® 750's colour allows differentiation for guarding against migration into critical areas as well as providing background differentiation for product inspection.

SKU	SIZE	SHEETS/PACK	PACKS/CASE
BS750.0404.40	10x10cm	300	40
BS750.0909.20	23x23cm	300	20
BS750.1212.20	30x30cm	150	20

Blue color, smooth, absorbent and durable

**Durx® 570** 55% cellulose/45% polyester  
Durx® 570 is a lightweight, economical, general purpose wiper that is smooth, highly absorbent and durable.

SKU	SIZE	SHEETS/PACK	PACKS/CASE
DR570.0909.10	23x23cm	300	10
DR570.1212.20	30x30cm	150	20

No binders or chemical additives

**Durx® 670** 55% cellulose/45% polyester  
Durx® 670 is an economical general purpose wiper that is smooth, highly absorbent and durable. Roll version available.

SKU	SIZE	SHEETS/PACK	PACKS/CASE
DR670040410	10x10cm	1200	10
DR670040440	10x10cm	300	40
DR670070712	18x18cm	300	12
DR670090910	23x23cm	300	10
DR670090920	23x23cm	300	20
DR670121220	30x30cm	150	20
DR670181810	46x46cm	150	10
DR670.3438.R	34x38cm	500	1
GW67ST0980*	23x23cm	20	80
GW67ST25*	30x30cm	20	25
GW67ST60*	30x30cm	5	60

Meets AMS 3819, Class 2, Grade A, Form 1  
FDA 21 CFR, Food Contact Compliant  
QPL-BMS-15-5

\* Sterile Version  
Gamma irradiated and sterile validated to a 10<sup>-6</sup> Sterility Assurance Level per ANSI/AAMI/ISO guidelines - EU Grade A/B/C/D

## NONWOVEN WIPERS - LOT TO LOT TRACEABILITY - AUTOCLAVABLE

### Durx® 770

55% cellulose/45% polyester

Durx® 770 is a treated wiper for applications requiring lower fibre and particle counts than average nonwovens.

SKU	SIZE	SHEETS/PACK	PACKS/CASE
DR770040410	10x10cm	1200	10
DR770070712	18x18cm	300	12
DR770090920	23x23cm	300	20
DR770121220	30x30cm	150	20
DR770181810	46x46cm	150	10

Enhanced with an ultra low particle and fibre treatment

### EcoClean® 60

100% nonwoven cotton

EcoClean® 60 is excellent for sensitive surfaces and high temperature applications. It has high strength and resists build up of static charge.

SKU	SIZE	SHEETS/PACK	PACKS/CASE
ECW60.0909.20	23x23cm	300	20

FDA 21 CFR, Food Contact Compliant, 100% biodegradable

### MicroFirst®

45% cellulose/55% polyester

MicroFirst® is aperatured for increased absorbency and increased surface texture for improved cleaning efficiency.

SKU	SIZE	SHEETS/PACK	PACKS/CASE
MF.0909.20	23x23cm	300	20
MF.1212.20	30x30cm	150	20

Durable with high wet strength

### MicroFirst® LP Low Endotoxin

58% polyester/42% lyocell

MicroFirst® LP Low Endotoxin wipes have the highest combination of purity and absorbency available in nonwovens. It is soft and excellent for wiping delicate surfaces. It is the cleanest nonwoven option.

SKU	SIZE	SHEETS/PACK	PACKS/CASE
MFLP090912LE	23x23cm	150	12
GWMFLPST25LE*	30x30cm	20	25

No binders or chemical additives

### ProjX® 700

55% cellulose/45% polyester

ProjX® 700 is a lightweight industrial wiper. It has the excellent combination of synthetic polyester strength and cleanliness with the absorbency characteristics of cellulose.

SKU	SIZE	SHEETS/PACK	PACKS/CASE
PJ700.0909.20	23x23cm	200	20
PJ700.1212.20	30x30cm	150	20

Creped design for increased absorbency

### Pro-Wipe® 750

60% polypropylene/40% cellulose

Pro-Wipe® 750 is a multi-layer composite wiper with a cellulose layer thermally bonded between the two polypropylene outer layers, resulting in an extremely durable and pure, solvent resistant wiper with very low particle and fibre generation.

SKU	SIZE	SHEETS/PACK	PACKS/CASE
PW750090920	23x23cm	150	20
PW750121220	30x30cm	75	20

German BfR Recommendation XXXVI(June 2017) and EC Regulation 1935 (2004) Compliant

### Pro-Wipe® 880

100% polypropylene

Pro-Wipe® 880 is composed of multiple layers of polypropylene thermally bonded in a quilted construction. This combination results in exceptional cleanliness, absorbency, and chemical resistance to strong solvents, including acids.

SKU	SIZE	SHEETS/PACK	PACKS/CASE
PW880.0810.12	20x25cm	100	12
PW880.1212.12	30x30cm	100	12

German BfR Recommendation XXXVI(June 2017) and EC Regulation 1935 (2004) Compliant

### ValuClean® Plus

50% rayon/50% polyester

ValuClean® Plus is a high absorbency wiper compared to typical cellulose/polyester nonwovens. Its soft hand and low fibre shedding performance make it a good choice in critical cleaning applications where economy is important.

SKU	SIZE	SHEETS/PACK	PACKS/CASE
VCLP.0909.20	23x23cm	300	20
VCLP.1212.20	30x30cm	150	20

Rayon content for high absorbency (not autoclavable)



## SPECIALTY WIPERS - LOT TO LOT TRACEABILITY - AUTOCLAVABLE

### ISO CLASS 6-8

CLEANROOM CLASS 1000-100,000 | EU GRADE C/D

1 EXCELLENT 3 FAIR  
2 GOOD 4 NR

PRODUCT/SUBSTRATE	STERILE OPTION	ABSORBENCY	ABRASION RESISTANCE	SENSITIVE SURFACES	LOW-LINTING	SOLVENT COMPATIBLE
<b>LABX® 170</b> 80% abaca (manila hemp)/20% wood pulp		2	3	1	1	2
<b>LENSX® 90</b> 70% rayon/30% abaca (manila hemp)		2	3	1	1	2
<b>TWILLX® 1622</b> 100% cotton		1	1	3	3	2

#### Labx® 170

80% abaca (manila hemp)/20% wood pulp

Labx® 170 is a cleaner alternative to industrial tissues and wipers. It has excellent wet strength, is low linting, and is highly absorbent.

SKU	SIZE	SHEETS/PACK	PACKS/CASE
LB170.0909.40	23x23cm	500	40
LB170.1212.20	30x30cm	500	20
LB170.1818.10	46x46cm	500	10

Meets government specification AA-50177, Type 1, Class 4

#### Twillx® 1622

100% woven cotton

Twillx® 1622 is engineered for thermal stability and high heat applications. It is highly sorbent and durable.

SKU	SIZE	SHEETS/PACK	PACKS/CASE
T1622.0909.8	23x23cm	300	8
T1622.1212.4	30x30cm	150	4

Sturdy, durable and highly sorbent

#### Lensx® 90\*

70% rayon/30% abaca (manila hemp)

Lensx® 90 is a nonabrasive wiper engineered for extreme softness and for use in cleaning delicate surfaces.

SKU	SIZE	SHEETS/PACK	PACKS/CASE
LN90.0406.24	10x15cm	1000	24
LN90.0909.16	23x23cm	1000	16
LN90.1212.4	30x30cm	1000	4

Meets government specification AA-50177, Type 1, Class 1

### ISO CLASS 3-5

CLEANROOM CLASS 1-100 | EU GRADE B/C/D



#### DID YOU KNOW?

PureSorb® has an "Easy Open Notch". It is double bagged with an opaque white outer bag that prevents light from reaching the product, preventing discoloration.

#### PureSorb®

100% polyurethane foam

PureSorb® is a 100ppi open cell polyester-based polyurethane foam wiper. It is laundered and hydrophilic. The thickness of the wiper is 0.38cm.

SKU	SIZE	SHEETS/PACK	PACKS/CASE
PS040520	10x13cm	50	20
PS06098	15x23cm	50	8

Extremely pure and clean

#### MicroSeal® NW Antistatic

100% continuous filament polyester knit

MicroSeal® Antistatic is manufactured with antistatic fibre which attracts and dissipates static charges.

SKU	SIZE	SHEETS/PACK	PACKS/CASE
MSNW.0909.10	23x23cm	150	10

Sealed Edge, Cleanroom Laundered

# SATPAX® PRESATURATED WIPERS GUIDE

Sterile pre-wetted wipers have the lot no. on each pack with a 3 year shelf life.

## ADVANTAGES

**Health & Safety** - no mixing and storing of hazardous liquids

**Contamination** - minimise volatile organic compounds (VOCs)

**Control** - no over-spraying or wetting of surfaces

**Consistency** - problems associated with under-or over-wetting the wiper are eliminated

**Economy** - greater cleaning efficiency and cleaning protocol consistency and effectiveness can be obtained

## DEFINITIONS

**DI (deionised) Water:** Water that has had its mineral ions removed, such as cations from sodium, calcium, iron, copper and anions such as chloride and bromide.

**WFI (Water for Injection):** USP Water for Injection is prepared from water complying with quality attributes of "Drinking Water." Purified by distillation or a purification process that is equivalent or superior to distillation in the removal of chemicals or microorganisms. WFI water is tested and certified to be at or below a certain level of endotoxins.

**IPA:** Isopropyl alcohol can be produced in several distinct grades. The two most commonly used in pre-wetted wipers are USP and Semiconductor grades. The primary difference between the two grades is the level of purification. Semiconductor grades have much more stringent requirements for metallic content and therefore are much purer in use. USP grade is typically used for sterile products while semiconductor grade is typically used in all other products.

**VOCs:** Volatile organic compounds (VOCs) are organic chemicals that have a high vapour pressure at ordinary room temperature. Their high vapour pressure results from a low boiling point, which causes large numbers of molecules to evaporate or sublime from the liquid or solid form of the compound and enter the surrounding air.

SatPax® complies with the Global Harmonized System of Classification and Labeling of Chemicals



**"PRE-WETTED WIPERS  
OPTIMISED FOR  
APPLICATION-SPECIFIC  
CLEANING"**



## SATPAX® PRESATURATED WIPERS - LOT TO LOT TRACEABILITY

### ISO CLASS 3-5 CLEANROOM CLASS 1-100 | EU GRADE B/C/D

PRODUCT/SUBSTRATE	STERILE OPTION	PRODUCT FAMILY	SEALED BORDER	SEALED EDGE	CUT EDGE	SOLUTION OPTION	CANISTER OPTION
SATPAX® 3000 100% continuous filament polyester		Ultra-Seal® 3000	●			70% IPA/30% DI H <sub>2</sub> O	
SATPAX® MSVP 100% continuous filament polyester		MicroSeal®-VP		●		70% IPA/30% WFI	

#### SatPax® 3000

100% continuous filament polyester

SatPax® 3000 is a 2-ply pinsonic tubular wiper, constructed using a patented sealed edge process resulting in reduced fibre generation. It is available in a consistent 70% IPA/30% DI H<sub>2</sub>O.

SKU	SIZE	SHEETS/ PACK	PACKS/ CASE	SAT.	VOC%
SPX3000.001.12	23X23cm	30	12	33%	29%

Sealed Border Edge, Cleanroom Laundered, Resealable Packaging

#### SatPax® MSVP

100% continuous filament polyester

SatPax® MSVP is a lightweight wiper with a tightly knit material design. It is a presaturated with 70% IPA/30% WFI with a 60% saturation level for increased solution contact time. Low endotoxin version available

SKU	SIZE	SHEETS/ PACK	PACKS/ CASE	SAT.	VOC%
SPXVPR0012	23X23cm	30	12	60%	38%
SPXVP00112LE	23X23cm	30	12	60%	38%
SSPVP00112LE	23X23cm	30	12	60%	38%

Sealed Edge, Cleanroom Laundered, Resealable Packaging

### ISO CLASS 4-5 CLEANROOM CLASS 10-100 | EU GRADE B/C/D

PRODUCT/SUBSTRATE	STERILE OPTION	PRODUCT FAMILY	SEALED BORDER	SEALED EDGE	CUT EDGE	SOLUTION OPTION	CANISTER OPTION
SATPAX® 1200-R 100% continuous filament polyester	●	Super Polx® 1200			●	70% IPA/30% DI H <sub>2</sub> O	

#### SatPax® 1200-R

100% continuous filament polyester

SatPax® 1200-R is presaturated with a consistent 70% IPA/30% DI H<sub>2</sub>O solution with a higher saturation level for solution contact time in the regulated industries. The sterile version is gamma irradiated and sterile validated to a 10<sup>-6</sup> Sterility Assurance Level per ANSI/AAMI/ISO guidelines.

SKU	SIZE	SHEETS/ PACK	PACKS/ CASE	SAT.	VOC%
SPX120R.001.12	23X23cm	30	12	60%	40.9%
SSP12000312	23X23cm	30	12	60%	40.9%

Knife Cut Edge, Cleanroom Laundered, Resealable Packaging

#### DID YOU KNOW?

The SatPax® 1000 canister is made of HDPE high density polyethylene and therefore cannot be autoclaved. It can be gamma irradiated.



\* Sterile Version

Certificates of Sterility available on change to [www.berkshire.uk.com](http://www.berkshire.uk.com) by lot number 24/7 - EU Grade A/B/C/D

# SATPAX® PRESATURATED WIPERS - LOT TO LOT TRACEABILITY

## ISO CLASS 5-8

CLEANROOM CLASS 100-100,000 | EU GRADE B/C/D

PRODUCT/SUBSTRATE	STERILE OPTION	PRODUCT FAMILY	SEALED BORDER	SEALED EDGE	CUT EDGE	SOLUTION OPTION	CANISTER OPTION
<b>SATPAX® 550</b> 100% polypropylene	●				●	70% IPA/30% DI H <sub>2</sub> O 70% IPA/30% WFI	
<b>SATPAX® 670-R</b> 55% cellulose/45% polyester	●	Durx® 670			●	70% IPA/30% DI H <sub>2</sub> O	
<b>SATPAX® 1000</b> 55% cellulose/45% polyester	●	Durx® 670			●	70% IPA/30% DI H <sub>2</sub> O 9% IPA/91% DI H <sub>2</sub> O	●
<b>SATPAX® MicroFirst® LP Low Endotoxin</b> 58% polyester/42% lyocell	●	MicroFirst® LP				70% IPA/30% WFI	

### SatPax® 1000

55% cellulose/45% polyester

This wipe is a durable and strong general purpose wipe prewetted with a consistent 70% IPA/30% DI H<sub>2</sub>O solution.

SKU	SIZE	SHEETS/ PACK	PACKS/ CASE	SAT.	VOC%
SPX1000.001.12	23X23cm	75	12	45%	40%
SPX1000.002.12	23X23cm	75	12	45%	4.7%
SPXC1000.001.12	15X23cm	100	12	45%	40%
SPXC1000.01.12R	15X23cm	100	12	45%	40%
SPXC10000212	15X23cm	100	12	45%	4.7%
SPXC10000212R	15X23cm	100	12	45%	4.7%
SSP100000124*	23X23cm	30	24	60%	44%

Knife Cut Edge, Resealable Packaging and **Canisters with Refills**

### SatPax® 670-R

55% cellulose/45% polyester

SatPax® 670-R is a durable and strong presaturated wiper with a consistent 70% IPA/30% DI H<sub>2</sub>O solution with a higher saturation level of 60% for solution contact time in the regulated industries. The sterile version is gamma irradiated and sterile validated to a 10<sup>-6</sup> Sterility Assurance Level per ANSI/AAMI/ISO guidelines.

SKU	SIZE	SHEETS/ PACK	PACKS/ CASE	SAT.	VOC%
SPX670090912	23X23cm	25	12	60%	45.7%
SPX67091112	23X28cm	50	12	60%	45.7%
SPX670R.001.12	23X23cm	75	12	60%	44%
SSP67000124*	23X23cm	30	24	60%	44%

Knife Cut Edge, Resealable Packaging

Meets AMS 3819C requirements, Class 2, Grade A, Form 2

### SatPax® 550

100% polypropylene

SatPax® 550 is a lightweight wiper that has very low levels of fibres, particles and ions. It is presaturated with a consistent 70% IPA/30% DI H<sub>2</sub>O solution. The sterile version is gamma irradiated and sterile validated to a 10<sup>-6</sup> Sterility Assurance Level per ANSI/AAMI/ISO guidelines.

SKU	SIZE	SHEETS/ PACK	PACKS/ CASE	SAT.	VOC%
SPX550.001.24	23X28cm	50	24	71%	50.1%
SPX55000624LE	23X28cm	50	24		
SSP55000424*	23X28cm	50	24	62%	48.3%
SSP55000524LE*	23X28cm	50	24		

Knife Cut Edge, Resealable Packaging

### SatPax® MicroFirst® LP Low Endotoxin

58% polyester/42% lyocell

SatPax® MicroFirst® LP Low Endotoxin wipes are pure and soft presaturated with consistent 70% IPA/30% WFI. The sterile version is gamma irradiated and validated sterile to a 10<sup>-6</sup> Sterility Assurance Level per ANSI/AAMI/ISO guidelines.

SKU	SIZE	SHEETS/ PACK	PACKS/ CASE	SAT.	VOC%
SPXMFLP00112LE	23X23cm	75	12		
SSPMFLP00124LE*	23X23cm	30	24		

Knife Cut Edge, Resealable Packaging

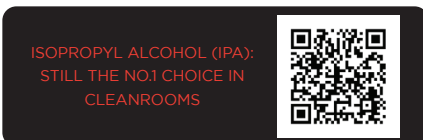
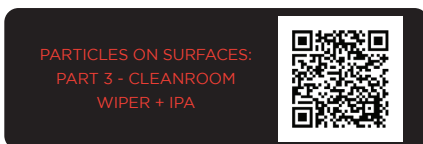



# STERILE AND GAMMA IRRADIATED PRODUCTS

## VALIDATED STERILE CLEANROOM WIPERS

- Gamma irradiated and sterile validated to a  $10^{-6}$  Sterility Assurance Level (SAL) per ANSI/AAMI/ISO guidelines
- Header bag style
- Lot number on each pack for traceability
- Certificate of Sterility(COS) available on berkshire.com by lot number 24/7

COS Details:

- Expiration Date, Radiation Dosage, Lot Information,
- Meets cGMP requirements for traceability

READ  
WHAT ARE VALIDATED  
STERILE WIPERS?



## STERILE DRY WIPERS

**ISO CLASS 3-5**  
CLEANROOM CLASS 1-100 | EU GRADE A/B/C/D

### Gamma Wipe SuperSorb®

100% continuous filament polyester knit

Gamma Wipe SuperSorb® 2-ply construction diamond pattern make this the most absorbent polyester wiper available. It has been gamma irradiated and sterile validated to a  $10^{-6}$  Sterility Assurance Level per ANSI/AAMI/ISO guidelines. Low endotoxin version available.

SKU	SIZE	SHEETS/ PACK	PACKS/ CASE
GWSSST16	30X30cm	10	16
GWSSST16LE	30X30cm	10	16

Sealed Edge, Cleanroom Laundered

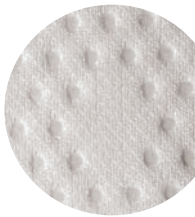

### Gamma Wipe® 300

100% continuous filament polyester knit

Gamma Wipe® 300 is a 2-ply pinsonic tubular wiper, constructed using a patented sealed edge process resulting in reduced fibre generation and superior absorbency. It has been gamma irradiated and sterile validated to a  $10^{-6}$  Sterility Assurance Level per ANSI/AAMI/ISO guidelines.

SKU	SIZE	SHEETS/ PACK	PACKS/ CASE
GW300ST25	30X30cm	10	25

Sealed Border Edge, Cleanroom Laundered



### Gamma Wipe® VP

100% continuous filament polyester knit

Gamma Wipe® VP is a cleanroom laundered lightweight wiper with a tightly knit material design that reduces the actual cost of use compared to heavier weight products. It has been gamma irradiated and sterile validated to a  $10^{-6}$  Sterility Assurance Level per ANSI/AMMI/ISO guidelines. Low endotoxin version available.

SKU	SIZE	SHEETS/ PACK	PACKS/ CASE
GWVPST0940	23X23cm	20	40
GWVPST25	23X23cm	20	25
GWVPST25LE	30X30cm	20	25

Sealed Edge, Cleanroom Laundered

**ISO CLASS 4-5**  
CLEANROOM CLASS 10-100 | EU GRADE A/B/C/D

### Gamma Wipe® 120

100% continuous filament polyester knit

Gamma Wipe® 120 is a knife cut cleanroom laundered wipe, with a soft hand and edge for sensitive surfaces. It has been gamma irradiated and sterile validated to a  $10^{-6}$  Sterility Assurance Level per ANSI/AAMI/ISO guidelines.

SKU	SIZE	SHEETS/ PACK	PACKS/ CASE
GW120ST0940	23X23cm	20	40
GW120ST15	30X30cm	20	15

## ISO CLASS 5-8

CLEANROOM CLASS 100-100,000 | EU GRADE A/B/C/D

### Gamma Wipe® 67

55% cellulose/45% polyester

Gamma Wipe® 67 is an economical wipe that is smooth, highly absorbent and durable. It has been gamma irradiated and sterile validated to a 10<sup>-6</sup> Sterility Assurance Level per ANSI/AAMI/ISO guidelines.

SKU	SIZE	SHEETS/ PACK	PACKS/ CASE
GW67ST0980	23X23cm	20	80
GW67ST25	30X30cm	20	25
GW67ST60	30X30cm	5	60

No binders or chemical additives

### Gamma Wipe® MFLP Low Endotoxin

58% polyester/42% lyocell

Gamma Wipe MicroFirst LP Low Endotoxin wipes have the highest combination of purity and absorbency available in nonwovens. It is soft and excellent for wiping delicate surfaces. It has been gamma irradiated and sterile validated to a 10<sup>-6</sup> Sterility Assurance Level per ANSI/AAMI/ISO guidelines.

SKU	SIZE	SHEETS/ PACK	PACKS/ CASE
GWMFLPST25LE	30X30cm	20	25

No binders or chemical additives

# STERILE PRESATURATED WIPERS

## KNITTED WIPERS - LOT TO LOT TRACEABILITY

ISO CLASS 3-5 CLEANROOM CLASS 10-100 | EU GRADE A/B/C/D

### Sterile SatPax® MSVP Low Endotoxin

100% continuous filament polyester knit

Sterile SatPax MSVP LE is presaturated with a consistent 70% IPA/30% DI H<sub>2</sub>O. It has been gamma irradiated and sterile validated to a 10<sup>-6</sup> Sterility Assurance Level per ANSI/AMMI/ISO guidelines.

SKU	SIZE	SHEETS/ PACK	PACKS/ CASE	SAT	VOC%
SSPV00112LE	23X23cm	30	12		

Knife cut edge, cleanroom laundered, resealable packaging

ISO CLASS 4-5 CLEANROOM CLASS 10-100 | EU GRADE A/B/C/D

### Sterile SatPax® 1200

100% continuous filament polyester knit

Sterile SatPax® 1200 is presaturated with a consistent 70% IPA/30% DI Water to a high saturation level for solution contact time in regulated industries. It has been gamma irradiated and sterile validated to a 10<sup>-6</sup> Sterility Assurance Level per ANSI/AAMI/ISO guidelines.

SKU	SIZE	SHEETS/ PACK	PACKS/ CASE	SAT	VOC%
SSP120000312	23X23cm	30	12	60%	40.9%

Knife cut edge, cleanroom laundered, resealable packaging

ISO CLASS 5-8 CLEANROOM CLASS 100-100,000 | EU GRADE A/B/C/D

### Sterile SatPax® 1000

55% cellulose/45% polyester

Sterile SatPax® 1000 is presaturated with a consistent 70% IPA/30% DI Water to a high saturation level of 60% for solution contact time in regulated industries. It has been gamma irradiated and sterile validated to a 10<sup>-6</sup> Sterility Assurance Level per ANSI/AAMI/ISO guidelines.

SKU	SIZE	SHEETS/ PACK	PACKS/ CASE	SAT	VOC%
SSP100000124	23X23cm	30	24	60%	44%

Resealable packaging, c-folded for single withdrawal

### Sterile SatPax® 670

55% cellulose/45% polyester

Sterile SatPax® 670 is presaturated with a consistent 70% IPA/30% DI Water to a high saturation level of 60% for solution contact time in regulated industries. It has been gamma irradiated and sterile validated to a 10<sup>-6</sup> Sterility Assurance Level per ANSI/AAMI/ISO guidelines.

SKU	SIZE	SHEETS/ PACK	PACKS/ CASE	SAT	VOC%
SSP67000124	23X23cm	30	24	60%	44%

Resealable packaging, c-folded for single withdrawal

### Sterile SatPax® MicroFirst LP Low Endotoxin

58% polyester/42% lyocell

Sterile SatPax MicroFirst LP Low Endotoxin wipes are pure and soft presaturated with consistent 70% IPA/30% WFI and validated sterile.

SKU	SIZE	SHEETS/ PACK	PACKS/ CASE	SAT	VOC%
SSPMFLP00124LE	23X23cm	30	24		

Knife Cut Edge, Resealable Packaging

### Sterile SatPax® 550

100% meltblown polypropylene

Sterile SatPax® 550 is a knife cut edge lightweight wiper presaturated with a consistent 70% IPA/30% DI Water. The wipe has very low levels of fibres, particles and ions. It has been gamma irradiated and sterile validated to a 10<sup>-6</sup> Sterility Assurance Level per ANSI/AAMI/ISO guidelines. Low endotoxin version available.

SKU	SIZE	SHEETS/ PACK	PACKS/ CASE	SAT	VOC%
SSP55000424	23X28cm	50	24	62%	48.3%
SSP5500524LE	23X28cm	50	24	62%	48.3%

Resealable packaging, c-folded for single withdrawal

# STERILE MOP COVERS & MOP HEADS

## Validated Sterile EasyClean® 360 Isolator Cleaning Tool Cover



100% continuous filament polyester knit  
Laundered and packaged in an ISO Class 4 (Class 10) cleanroom, this validated sterile cover's stretch fabric and elastic edge enables easy installation and a secure fit on the isolator cleaning tool head. 1 foam-free cushioned padded cover is included.

### SKU

EC360ECST20

### SHEETS/ PACK

10 ELASTIC COVERS  
+ 1 PADDED COVER

### PACKS/ CASE

20

Excellent for PEC cleaning (Primary Engineering Control)



## Choice Validated Sterile Padded EasyClean® 360 Isolator Cleaning Tool Cover

100% continuous filament polyester knit  
Laundered and packaged in an ISO Class 4 (Class 10) cleanroom, this validated sterile cover's foam-free cushioned design insures even surface coverage with reduced residues.

### SKU

EC360CHPST40  
SSPEC360P40\*

### SHEETS/ PACK

5 PADDED COVERS  
5 PADDED COVERS

### PACKS/ CASE

40  
40

Sterile cover presaturated with 70% IPA/30% DI H<sub>2</sub>O available

## GAMMA IRRADIATED - LOT TO LOT TRACEABILITY

### BCR® Mop 4 Gamma Irradiated



100% knitted polyester  
Laundered and cleaned in an ISO Class 4 (Class 10) cleanroom, this gamma irradiated looped string mop head has low particulates and fibres. It has excellent chemical and abrasion resistance.

### SKU

BCM4IR12

### MOPS/ PACK

1

### MOPS/ CASE

12

Works well with most mops clamps

### Folding Flat Mop Cover 1 Gamma Irradiated

68 gsm polyester/cellulose outercover  
100% rayon nonwoven inner layer Mop cover has high absorbency capacity and high tear strength. Certificates of irradiation with each case.

### SKU

FMC1IR10

### SIZE

13X40cm

### MOPS/ PACK

20

### MOPS/ CASE

10

### Ergonomic Flat Mop Cover Gamma Irradiated

Microfiber polyester/nylon fibres  
Blue twisted loop microdenier mop cover. Three layer absorbency, individually wrapped.

### SKU

FMC8MD10IR

### SIZE

45X15cm

### MOPS/ PACK

6

### MOPS/ CASE

10

#### DID YOU KNOW?

Certificates of Sterility are available 24/7 on [berkshire.uk.com](http://berkshire.uk.com)

**GAMMA IRRADIATED  
VS.  
VALIDATED STERILE**



#### DID YOU KNOW?

Certificates of Irradiation are available 24/7 on [berkshire.uk.com](http://berkshire.uk.com)

# CHOICE® WIPER SELECTION GUIDE



# CHOICE®

from **Berkshire®**

**CHOICE®** is a value tiered category of wipers offering all the performance consistency of higher priced wipers. Best of all, **CHOICE®** is from **Berkshire**, the most trusted name in cleanroom supplies, which means quality you can count on.

## PACKAGING

All Berkshire wipers come in high quality, chemical resistant packaging material that has been tested for cleanroom use. All the wipers are double bagged for easy transfer and wipe down. **CHOICE®** wipers are packaged in stacked and value (bulk) configurations.

## VALUE (BULK) PACKAGING

Value (bulk) packaged product is placed into a bag with a cursory inspection. The sheet count is arrived at by weight. There is 0% difference in performance between a value (bulk) packed and stacked product. There is however, a cost savings in a value (bulk) packaged wiper.

## STACKED PRODUCT

Each wiper is inspected and stacked one on top of the other. The end result is a square pack that allows each wiper to be removed individually from the stack.

**KNITTED WIPERS** - LOT TO LOT TRACEABILITY - AUTOCLAVABLE

**ISO CLASS 3-5**  
CLEANROOM CLASS 1-100 | EU GRADE B/C/D

PRODUCT/SUBSTRATE	CLEANROOM LAUNDERED	EDGE TYPE	COMPATIBLE WITH IPA, ACETONE, AND OTHER SOLVENTS	VALUE (BULK) OPTION
<b>CHOICE® SuperSorb</b> 100% continuous filament polyester	•	Sealed Edge	•	
<b>CHOICE® 900</b> 100% continuous filament polyester	•	Sealed Edge	•	

**CHOICE® SuperSorb**

100% continuous filament polyester

CHOICE® SuperSorb is a 2-ply pinsonic constructed cleanroom wiper with a unique diamond pattern. High abrasion resistance with excellent absorbency.

SKU	SIZE	SHEETS/PACK	PACKS/CASE
CHSS0414	10x10cm	300	14
CHSS09.14	23x23cm	75	14
CHSS12.12	30x30cm	75	12

Sealed Edge, 2-ply, Cleanroom Laundered

**CHOICE® 900**

100% continuous filament polyester

CHOICE® 900 has high abrasion resistance with excellent absorbency. Its ultrasonically sealed edges reduce fibre and particle contamination.

SKU	SIZE	SHEETS/PACK	PACKS/CASE
CH909.10	23x23cm	150	10



# NONWOVEN WIPERS - LOT TO LOT TRACEABILITY - AUTOCLAVABLE

## ISO CLASS 5-8

CLEANROOM CLASS 100-100,000 | EU GRADE B/C/D

PRODUCT/SUBSTRATE	CLEANROOM LAUNDERED	EDGE TYPE	COMPATIBLE WITH IPA, ACETONE, AND OTHER SOLVENTS	VALUE (BULK OPTION)
<b>CHOICE® Nonwoven 500</b> 60% cellulose/40% polyester		Knife Cut Edge	•	
<b>CHOICE® Nonwoven 600</b> 55% cellulose/45% polyester		Knife Cut Edge	•	
<b>CHOICE® SatPax 500</b> Presaturated 60% cellulose/40% polyester		Knife Cut Edge	•	
<b>CHOICE® SatPax 600</b> Presaturated 55% cellulose/45% polyester		Knife Cut Edge	•	

### CHOICE® Nonwoven 500

60% cellulose/40% polyester

CHOICE® is a lighter weight economical all purpose wiper. It is smooth, absorbent and durable.

SKU	SIZE	SHEETS/PACK	PACKS/CASE
CHNW50920	23x23cm	400	20
CHNW51220	30x30cm	200	20

No binders or chemical additives, Stacked

### CHOICE® SatPax 500

60% cellulose/40% polyester

CHOICE® SatPax 500 is a lighter weight smooth and durable presaturated wiper with a consistent 70% IPA/30% DI H2O solution. Reduces VOC emissions.

SKU	SIZE	SHEETS/PACK	PACKS/CASE	SATURATION
SPXCHN500112	23x23cm	75	12	45%
SPXCHN5R00112	23x23cm	75	12	60%

No chemical binders in base material, Resealable Packaging

### CHOICE® Nonwoven 600

55% cellulose/45% polyester

CHOICE® Nonwoven 600 economical all purpose wiper. It is smooth, absorbent and durable.

SKU	SIZE	SHEETS/PACK	PACKS/CASE
CHNW60440	10x10cm	300	40
CHNW60920	23x23cm	300	20
CHNW61220	30x30cm	150	20

No binders or chemical additives, Stacked

### CHOICE® SatPax 600

55% cellulose/45% polyester

CHOICE® SatPax 600 is a smooth and durable presaturated wiper with a consistent 70% IPA/30% DI H2O solution. Reduces VOC emissions.

SKU	SIZE	SHEETS/PACK	PACKS/CASE	SATURATION
SPXCHN600112	23x23cm	75	12	45%
SPXCHN6R00112	23x23cm	75	12	60%

No chemical binders in base material, Resealable Packaging

#### DID YOU KNOW?

Isopropyl Alcohol (IPA)  
is still the

NO.1 CHOICE IN  
CLEANROOMS



# CHOICE® MOPS & ACCESSORIES

## CHOICE® MicroFibre Looped String Mop Head

Microfibres are tiny fibres that have been split to produce ultra-fine fibers estimated to be at least 0.16cm the size of a human hair. When knitted together these fibres create a surface area covered with millions of spaces between the fibres to trap moisture, dirt and debris. This technology allows for the dirt and liquids to be “picked up” rather than being pushed around.

### Features and Advantages

- White 88% polyester/12% nylon microfibre string mop with blue headband and tailband
- Microfibre yarns attract and trap dirt and debris
- Terry knit structure enhances absorbency to increase efficiency
- Tubular knit construction with sewn head and tail bands provides added durability
- Lot number assures traceability
- Autoclavable

SKU	PACKAGING	MOPS/PACK	MOPS/CASE
CHMFM.24	INDIVIDUALLY WRAPPED	1	24

## CHOICE® Mop Handle & Clamp

Economical CHOICE® lightweight mop handle & clamp accommodates most size string and loop mop heads.

### Handle: Features and Advantages

- Anodised aluminum handle with blue polypropylene hand grip
- Fixed length at 140cm
- Easily connects to clamp
- Corrosion and chemical resistant
- Not autoclavable

### Clamp: Features and Advantages

- Blue polypropylene mop clamp
- Latch-style swing-away bar for quick and easy mophead changes
- Easily connects to handle
- Corrosion and chemical resistant
- Autoclavable

PRODUCT	SKU	PACKAGING	MOPS/HANDLES/ CASE
CHOICE MOP HANDLE & CLAMP SET	CHMH.SET.1	1 HANDLE & 1 CLAMP	1

## CHOICE® EasyClean 360 Padded Covers

100% continuous filament polyester

Laundered and packaged in an ISO Class 4 (Class 10) clean-room, this cover’s foam-free cushioned design insures even surface coverage with reduced residues.

SKU	PADS/PACK	PACKS/CASE
EC360CHP40	5	40
EC360CHPST40	5	40
SSPEC360P40	5	40



### DID YOU KNOW ?

The mop head can be relaunched and re-used. Specific laundry instructions can be found on Product Information Sheet on berkshire.com.



\* Sterile Version

Gamma irradiated and sterile validated to a 10<sup>-6</sup> Sterility Assurance Level per ANSI/AAMI/ISO guidelines - EU Grade A/B/C/D

# CHOICE® CLEANROOM FACE MASKS AND SOCKS

## EASY BREATHING COMFORT WITH SUPERIOR PERFORMANCE

People are a significant source of contamination in any critical manufacturing process. Berkshire masks are designed to protect your cleanroom from human contamination. Berkshire masks provide comfort for operators.

### Choice® Mask 3-Layer Nonwoven Polypropylene spunbound, hydrophobic/Polyester Earloops

- Individually wrapped
- Knitted polyester earloops provide comfort to wearers
- Polypropylene provide excellent filtration

SKU	SIZE	MASKS/ PACK	PACKS/ CASE	INNERFACING MEDIUM	FILTER	OUTERFACING
CHFM18024I	180mm	25	24	NONWOVEN POLYPROPYLENE	POLYPROPYLENE	NONWOVEN POLYPROPYLENE

### Choice® Mask 3-Layer Nonwoven Polypropylene spunbound, hydrophobic/Polyester Earloops

- Bulk packed
- Knitted polyester earloops provide comfort to wearers
- Polypropylene provide excellent filtration

SKU	SIZE	MASKS/ PACK	PACKS/ CASE	INNERFACING MEDIUM	FILTER	OUTERFACING
CHFM18040B	180mm	50 (BULK)	40	NONWOVEN POLYPROPYLENE	POLYPROPYLENE	NONWOVEN POLYPROPYLENE

### Choice® Cleanroom Socks

99% continuous filament polyester/1 % Spandex

#### Technical Data

DESCRIPTION	AVERAGE DATA	TEST METHOD
Polyester Cotton Sports Sock	45,000	0.5 µm Helmke Drum: Particles ≥ 0.5 µm/ft <sup>3</sup>
Choice Cleanroom Sock	120	0.5 µm Helmke Drum: Particles ≥ 0.5 µm/ft <sup>3</sup>

PRODUCT	NUMBER	SIZE	PRS/PK	PKS/CS	STYLE PACKED
CHOICE®CLEANROOM SOCK	CHSOCKR1050	ONE-SIZE-FITS-ALL	10	50	STACKED



#### Advantages

- Mid-calf length with elastic cuff for secure fit
- Soft and comfortable
- Laundered and packaged in a Class 5 cleanroom
- Meets the requirements of EU GMP Annex 1 section 7.15
- Autoclavable (121° C, 30 minutes)

#### DID YOU KNOW ?

Test results for Particle Filtration Efficiency, Bacterial Filtration Efficiency, Differential Pressure and Helmke Drum can be found on Product Information Sheets located at [berkshire.com/product-data](http://berkshire.com/product-data)

**CAN CLEANROOM  
FACE MASKS CAUSE  
SKIN IRRITATION?**





# PRO-WIPE® INDUSTRIAL WIPERS GUIDE



**Pro-Wipe®**  
INDUSTRIAL PRODUCTS from Berkshire



## Pro-Wipe® OS

100% polypropylene

Pro-Wipe® OS is specifically designed to absorb oil and repel water.

Advantages:

- Lot to lot traceability
- Complies with FDA 21 CFR 176.170 - 177.1520 for food grade applications (3rd party test data available)
- Excellent resistance to acids and bases
- Low linting

SKU	SIZE	STYLE	SHEETS/PACK	PACKS/CASE
PWOS12.12	30X30cm	FLAT PACK	100	12

## Pro-Wipe® AP

50% rayon/50% polyester

Pro-Wipe® AP is an all purpose wiper. It is tough enough to be a rag replacement and clean enough for a controlled environment.

Advantages:

- Lot to lot traceability
- Smooth and soft with high strength and durability
- High absorbency compared to typical cellulose/polyester nonwoven wipers
- Low linting and abrasion resistant

SKU	SIZE	STYLE	SHEETS/PACK	PACKS/CASE
PWAP09.24	23X23cm	FLAT PACK	150	24
PWAP12.24	30X30cm	FLAT PACK	100	24
PWAP.1213QF.20	30X33cm	QUARTER FOLDED	50	20
PWAP.PR0915.4	23X38cm	PERFORATED ROLL	250	4

## Pro-Wipe® SuperSorb

80% cellulose/10% lyocell/10% biocomponent

Pro-Wipe® SuperSorb is a medium duty all purpose wipe that is clean enough for controlled environments.

Advantages

- Absorbs water and oil based solutions
- Good wet strength
- Chemically compatible with common cleaning and disinfecting solutions
- Dispenser box available

SKU	SIZE	STYLE	SHEETS/PACK	PACKS/CASE
PWSS1114QF18	27X35cm	QUARTER FOLDED	50	18
PWSS0914D16	23X36cm	C FOLD (DISPENSER)	90 (S/P)	16 (D/C)

## Pro-Wipe® SuperSorb Lite

80% cellulose/10% lyocell/10% biocomponent

Pro-Wipe® SuperSorb Lite is a light duty all purpose wipe that is clean enough for controlled environments.

Advantages

- Chemically compatible with common cleaning and disinfecting solutions
- Smooth and soft with high strength and durability
- Dispenser box available with wipes

SKU	SIZE	STYLE	SHEETS/PACK	PACKS/CASE
PWSSL1114QF18	27X35cm	QUARTER FOLDED	50	18
PWSSL0914D16	23X36cm	C FOLD (DISPENSER)	110 (S/P)	16 (D/C)



# BCR® DOCUMENTATION SYSTEMS



Paper and notebooks can be a major source of particles, bacteria and micro-organisms in the cleanroom. BCR® Documentation Systems are made with the highest quality BCR® Bond paper to minimise contamination.

**ISO CLASS 3-7**  
CLEANROOM CLASS 1 - 10,000 | EU GRADE B/C/D

## BCR® Bond: Single Sheet Cleanroom Paper

104 g/m<sup>2</sup>

PRODUCT	COLOR	WEIGHT	SKU	SIZE	SHEETS/PACK	PACKS/CASE	DOUBLE PACKED
BCR® BOND 1040	WHITE	HEAVY	B104A3WH2505	A3	250	5	●
BCR® BOND 1040	WHITE	HEAVY	B104A4W25010	A4	250	10	●
BCR® BOND 1040	WHITE	HEAVY	B104A5W25020	A5	250	20	●
BCR® BOND 1040	BLUE	HEAVY	B104A3BL2505	A3	250	5	●
BCR® BOND 1040	BLUE	HEAVY	B104A4B25010	A4	250	10	●
BCR® BOND 1040	BLUE	HEAVY	B104A5B25020	A5	250	20	●

85 g/m<sup>2</sup>

PRODUCT	COLOR	WEIGHT	SKU	SIZE	SHEETS/PACK	PACKS/CASE	DOUBLE PACKED
BCR® BOND 850	WHITE	MEDIUM	B85A3WH2505	A3	250	5	●
BCR® BOND 850	WHITE	MEDIUM	B85A4WH25010	A4	250	10	●
BCR® BOND 850	WHITE	MEDIUM	B85A5WH25020	A5	250	20	●
BCR® BOND 850	BLUE	MEDIUM	B85A3BL2505	A3	250	5	●
BCR® BOND 850	BLUE	MEDIUM	B85A4BL25010	A4	250	10	●
BCR® BOND 850	BLUE	MEDIUM	B85A5BL25020	A5	250	20	●
BCR® BOND 850	PINK	MEDIUM	B85A4PK25010	A4	250	10	●
BCR® BOND 850	GREEN	MEDIUM	B85A4GN25010	A4	250	10	●
BCR® BOND 850	YELLOW	MEDIUM	B85A3YL2505	A3	250	5	●
BCR® BOND 850	YELLOW	MEDIUM	B85A4YL25010	A4	250	10	●

68 g/m<sup>2</sup>

PRODUCT	COLOR	WEIGHT	SKU	SIZE	SHEETS/PACK	PACKS/CASE	DOUBLE PACKED
BCR® BOND 680	WHITE	LIGHT	B68A3WH2505	A3	250	5	●
BCR® BOND 680	WHITE	LIGHT	B68A4WH25010	A4	250	10	●
BCR® BOND 680	BLUE	LIGHT	B68A3BL2505	A3	250	5	●
BCR® BOND 680	BLUE	LIGHT	B68A4BL25010	A4	250	10	●

### ADVANTAGES

- Autoclavable (not recommended for blue bond)
- Purest cellulose minimises contamination
- Full lot tracing on every case ensures consistent quality and control
- Specialised coating reduces particles and fibres generation
- Retains ink from laser copiers and ball point pens. Not compatible with ink jet printers.
- Heat resistant under extreme printer temperatures

### APPLICATIONS

- Cleanroom manuals, work instructions, standard operating procedures (SOPs)

*NATURAL RUBBER-LATEX FREE*

## BCR® DOCUMENTATION SYSTEMS

### ISO CLASS 3-7

CLEANROOM CLASS 1 - 10,000 | EU GRADE B/C/D

#### EcoBond®: Single Sheet Recyclable Cleanroom Paper

85 g/m<sup>2</sup>

PRODUCT	COLOR	WEIGHT	SKU	SIZE	SHEETS/PACK	PACKS/CASE	DOUBLE PACKED
ECOBOND®	WHITE	MEDIUM	EC085A3WH	A3	250	10	●
ECOBOND®	WHITE	MEDIUM	EC085A4WH	A4	250	10	●
ECOBOND®	BLUE	MEDIUM	EC085A3BL	A3	250	10	●
ECOBOND®	BLUE	MEDIUM	EC085A4BL	A4	250	10	●

#### ADVANTAGES

- Full lot tracing on every case ensures consistent quality and control
- Talc free
- Good toner adhesion
- High strength and heat resistance
- White colour sterilisable by autoclave and gamma (blue not autoclavable)

#### APPLICATIONS

- Cleanroom manuals, work instructions, standard operating procedures (SOPs)

### ISO CLASS 3-7

CLEANROOM CLASS 1 - 10,000 | EU GRADE B/C/D

#### BCR® Mynotes Notebooks

85 g/m<sup>2</sup>

PRODUCT	COLOR	WEIGHT AND STYLE	SKU	SIZE	NTBK/ PACK	PACKS/ CASE	DOUBLE PACKED
BCR® MYNOTES NOTEBOOK	WHITE	COLLEGE RULE	MNBKA4CR	A4	1	20	●
BCR® MYNOTES NOTEBOOK	WHITE	GRID	MNBKA4GRID	A4	1	20	●
BCR® MYNOTES NOTEBOOK	WHITE	COLLEGE RULE	MNBKA5CR	A5	1	30	●
BCR® MYNOTES NOTEBOOK	WHITE	GRID	MNBKA5GRID	A5	1	30	●
BCR® MYNOTES NOTEBOOK	WHITE	COLLEGE RULE	MNBKMEMOCR	MEMO	1	40	●

### ISO CLASS 3-7

CLEANROOM CLASS 1 - 10,000 | EU GRADE B/C/D

#### BCR® CleaNotes®

104 g/m<sup>2</sup>

PRODUCT	COLOR	WEIGHT AND STYLE	SKU	SIZE	PADS/ PACK	PACKS/ CASE	DOUBLE PACKED
BCR® CLEANOTES®	WHITE	HEAVY	BCN.0303.24	76X76mm	100	24	●

A special adhesive backing allows CleaNotes® to easily stick to any surface without leaving residues behind when the note is removed.

# BCR® GLOVE LINERS - GLOVE LINERS ARE EXCELLENT FOR UNDER GLOVES/GLOVING.

## HAND HEALTH AND OPERATOR COMFORT

BCR® glove liners are manufactured without the use of latex. Glove liners enhance operator comfort by reducing perspiration and contact/heat dermatitis associated with wearing latex, nitrile, neoprene and other gloves. They are ambidextrous for easy stock control and can be re laundered for multiple use.

Each glove liner is constructed using a special seamless technique.

### BCR® Polyester Glove Liners

Lightweight

PRODUCT	SKU	SIZE	CUFF COLOR	PAIRS/PACK	PACKS/CASE
BCR® HALF-FINGER	BGL2.20R	REGULAR	WHITE	10	20
BCR® HALF-FINGER	BGL2.200BR	REGULAR	WHITE	200 (BULK)	1
BCR® HALF-FINGER	BGL2.20L	LARGE	BLUE	10	20
BCR® FULL-FINGER	BGL3.20R	REGULAR	WHITE	10	20
BCR® FULL-FINGER	BGL3.20L	LARGE	BLUE	10	20

### BCR® Single Knit Nylon Glove Liners

Medium Weight

PRODUCT	SKU	SIZE	CUFF COLOR	PAIRS/PACK	PACKS/CASE
BCR® HALF-FINGER	BGL6.200SB	SMALL	GREEN	200 (BULK)	1
BCR® HALF-FINGER	BGL6.200LB	LARGE	BLACK	200 (BULK)	1
BCR® FULL-FINGER	BGL7.200SB	SMALL	RED	200 (BULK)	1
BCR® FULL-FINGER	BGL7.200MB	MEDIUM	ORANGE	200 (BULK)	1
BCR® FULL-FINGER	BGL7.200LB	LARGE	BLUE	200 (BULK)	1
BCR® FULL-FINGER	BGL7.200XLB	X-LARGE	RED	200 (BULK)	1



Half-finger versions are ideal for operators who need to retain maximum dexterity and fingertip sensitivity.

Each glove size has a coloured cuff for easy stock control.

### BCR® Ultra Glove Liners

Medium Weight

Fortify•AM® and Fortify Sta•Cool® Polyester Glove Liners

PRODUCT	SKU	SIZE	CUFF COLOR	PAIRS/PACK	PACKS/CASE
BCR® HALF-FINGER	BGL2U20R	REGULAR	GREY	10	20
BCR® HALF-FINGER	BGL2U20L	LARGE	PURPLE	10	20
BCR® FULL-FINGER	BGL3U20R	REGULAR	GREY	10	20
BCR® FULL-FINGER	BGL3U20L	LARGE	PURPLE	10	20

Fortify•AM® technology protects the fabric from microbial growth. The protection does not diminish with laundering and reuse.

Fortify Sta•Cool® technology provides the glove liners with superior cool feeling for extreme moisture management. They reduce the odour caused by hand perspiration.

# LAB-TIPS® SWABS GUIDE

Berkshire's LabTips® swabs are exceptionally pure for precision cleaning, surface sampling, applying lubricants and other liquids, and other validation procedures.

## SWAB SELECTION GUIDE

PRODUCT	HEAD MATERIAL	SWAB FORM	HEAD TYPE	HANDLE LENGTH	LAUNDERED	TOC	ESD
LTP70F	KNITTED POLYESTER	SOCK	FLEXIBLE	SHORT	●		
LTP70R	KNITTED POLYESTER	SOCK	RIGID	SHORT	●		
LTP125	KNITTED POLYESTER	SOCK	RIGID	MEDIUM	●		
LTP125S	KNITTED POLYESTER	SOCK	SEMI-FLEXIBLE	MEDIUM	●		
LTP146S	KNITTED POLYESTER	SOCK	FLEXIBLE	LONG	●		
LTP1465ESD	KNITTED POLYESTER	SOCK	FLEXIBLE	LONG	●		●
LTO70F	OPEN CELL FOAM	SOCK	FLEXIBLE	SHORT	●		
LTO70R	OPEN CELL FOAM	SOCK	RIGID	SHORT	●		
LTO70RESD	OPEN CELL FOAM	SOCK	RIGID	SHORT	●		●
LTO70P	OPEN CELL FOAM	SOCK	RIGID	SHORT	●		
LTO70PESD	OPEN CELL FOAM	SOCK	RIGID	SHORT	●		●
LTA03163	OPEN CELL FOAM	SOCK	RIGID	SHORT	●		
LT000125	OPEN CELL FOAM	SOCK	RIGID	MEDIUM	●		
LT0146S	OPEN CELL FOAM	SOCK	FLEXIBLE	LONG	●		
LTC125	CLOSED CELL FOAM	SOCK	RIGID	MEDIUM	●		
LTN70F	NONWOVEN POLYESTER	SOCK	FLEXIBLE	SHORT			
LTN146S	NONWOVEN POLYESTER	SOCK	FLEXIBLE	LONG			

## CONSTRUCTION

Sock tips are made by sandwiching the swab handle between multiple layers of thermoplastic head material. The head material is completely sealed and bonded to the handle with heat and pressure. No contaminating adhesives are used in the manufacturing of Berkshire's sock tip swabs.

## PACKAGING

Lab-Tips® are double bagged in cleanroom bags manufactured from high purity polyethylene resin that ensures ultra-low organic and inorganic residues. Bags are free from silicone, amides, and DP and comply with RoHS directives. An easy tear notch and solvent resistant inner pack labels ensure ease of use.

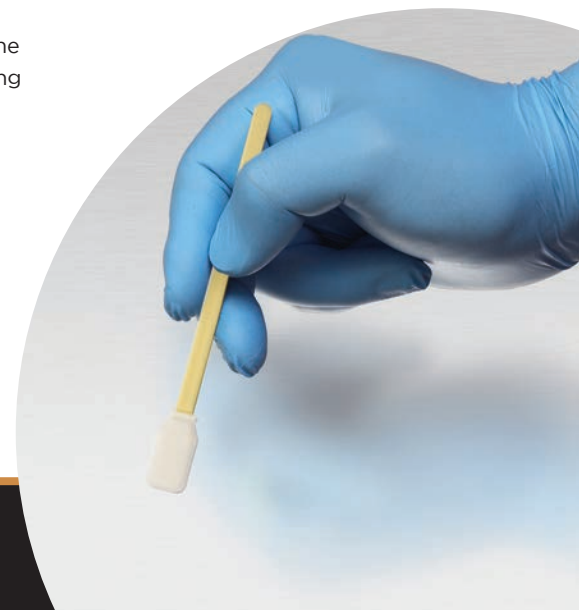

## LAB-TIPS® KNITTED POLYESTER SWABS

### CLEANROOM LAUNDERED DOUBLE LAYER 100% POLYESTER KNIT SWAB HEADS

Berkshire's knitted polyester swabs are made from cleanroom laundered, continuous filament polyester for exceptional purity. They offer low ionic contamination levels along with excellent durability and absorbent capacity. Knitted polyester swabs have excellent chemical resistance and are compatible with organic solvents. The handles are made of 100% polypropylene.

SKU	HEAD WIDTH	HEAD THICKNESS	HEAD LENGTH	HANDLE WIDTH	HANDLE THICKNESS	HANDLE LENGTH	TOTAL SWAB LENGTH	PACKAGING
LTP70F.20	4.0mm	2.5mm	11.0mm	2.2mm	2.2mm	59.0mm	70.0mm	100 SWABS/PACK 20 PACKS/CASE

Polyester swab with flexible paddle head for cleaning grooved, slotted and recessed areas.

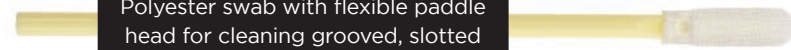

SKU	HEAD WIDTH	HEAD THICKNESS	HEAD LENGTH	HANDLE WIDTH	HANDLE THICKNESS	HANDLE LENGTH	TOTAL SWAB LENGTH	PACKAGING
LTP70R.20	4.0mm	4.0mm	12.5mm	2.8mm	2.8mm	58.0mm	70.0mm	100 SWABS/PACK 20 PACKS/CASE

Polyester swab with a short handle and rigid core provide firm support and precise control

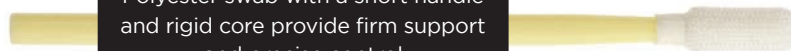

SKU	HEAD WIDTH	HEAD THICKNESS	HEAD LENGTH	HANDLE WIDTH	HANDLE THICKNESS	HANDLE LENGTH	TOTAL SWAB LENGTH	PACKAGING
LTP125.5	12.7mm	5.0mm	25.0mm	5.5mm	2.8mm	100.0mm	125.0mm	100 SWABS/PACK 5 PACKS/CASE

Polyester swab with a durable flat head provide maximum surface area for cleaning or sampling broad flat surfaces

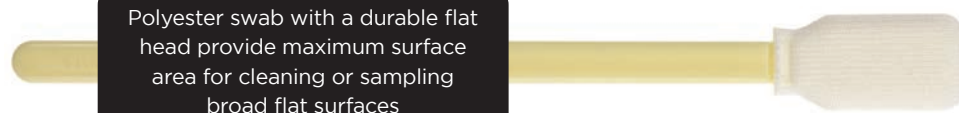

SKU	HEAD WIDTH	HEAD THICKNESS	HEAD LENGTH	HANDLE WIDTH	HANDLE THICKNESS	HANDLE LENGTH	TOTAL SWAB LENGTH	PACKAGING
LTP125S.25	12.7mm	5.0mm	25.0mm	5.5mm	2.8mm	100.0mm	125.0mm	20 SWABS/PACK 25 PACKS/CASE

Polyester sampling swab with a unique semi-flexible internal paddle and grooves on the handle for easy snapping

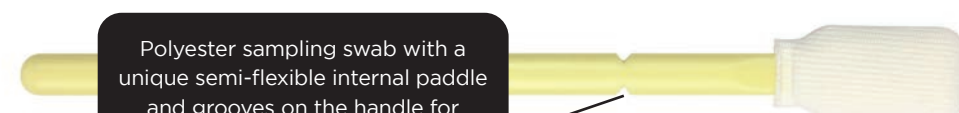

## LAB-TIPS® KNITTED POLYESTER SWABS

SKU	HEAD WIDTH	HEAD THICKNESS	HEAD LENGTH	HANDLE WIDTH	HANDLE THICKNESS	HANDLE LENGTH	TOTAL SWAB LENGTH	PACKAGING
LTP1465.10	7.0mm	4.0mm	16.8mm	3.1mm	3.1mm	145.0mm	162.0mm	100 SWABS/PACK 10 PACKS/CASE
LTP1465ESD.10	7.0mm	4.0mm	16.8mm	3.1mm	3.1mm	145.0mm	162.0mm	100 SWABS/PACK 10 PACKS/CASE

Polyester swab with a long handle for cleaning hard to reach areas has high abrasion resistance for rigorous cleaning applications

Swab features an ESD pink handle, engineered with a static dissipative polymer and is packaged in an anti-static bag

## LAB-TIPS® OPEN CELL (RETICULATED) FOAM SWABS

### CLEANROOM LAUNDERED 100 PPI OPEN CELL POLYURETHANE FOAM SWAB HEADS

Open Cell or reticulated foams are structures in which the cell windows have been removed by thermal or chemical means. This process results in a structure that has excellent liquid retention and particle entrapment capability. Berkshire's open cell foam swabs have excellent chemical resistance and are compatible with organic solvents.

PPI = Pores/Linear Inch. The number of cells per linear inch in the foam membrane. A measure of foam density.

SKU	HEAD WIDTH	HEAD THICKNESS	HEAD LENGTH	HANDLE WIDTH	HANDLE THICKNESS	HANDLE LENGTH	TOTAL SWAB LENGTH	PACKAGING
LTO70F.20	4.0mm	2.0mm	11.0mm	2.2mm	2.2mm	59.0mm	70.0mm	100 SWABS/PACK 20 PACKS/CASE

Foam swab with a short handle and flexible core for general purpose cleaning in confined areas with superior particle entrapment capability

SKU	HEAD WIDTH	HEAD THICKNESS	HEAD LENGTH	HANDLE WIDTH	HANDLE THICKNESS	HANDLE LENGTH	TOTAL SWAB LENGTH	PACKAGING
LTO70R.20	4.0mm	4.0mm	12.5mm	2.8mm	2.8mm	58.0mm	70.0mm	100 SWABS/PACK 20 PACKS/CASE
LTO70RES.20	4.0mm	4.0mm	12.5mm	2.8mm	2.8mm	58.0mm	70.0mm	100 SWABS/PACK 20 PACKS/CASE

Foam swab with a short handle and rigid core for general purpose cleaning in confined areas with superior particle entrapment capability

Swab features an ESD pink handle, engineered with a static dissipative polymer and is packaged in an anti-static bag

## LAB-TIPS® OPEN CELL (RETICULATED) FOAM SWABS

SKU	HEAD WIDTH	HEAD THICKNESS	HEAD LENGTH	HANDLE WIDTH	HANDLE THICKNESS	HANDLE LENGTH	TOTAL SWAB LENGTH	PACKAGING
LTO70P.20	4.0mm	4.0mm	20.0mm	2.5mm	2.5mm	50.0mm	70.0mm	100 SWABS/PACK 20 PACKS/CASEL
LTO70PESD20	4.0mm	4.0mm	20.0mm	2.5mm	2.5mm	50.0mm	70.0mm	100 SWABS/PACK 20 PACKS/CASE

Foam swab with a precision pointed head and a small tapered handle for cleaning small slotted and grooved areas



Swab features an ESD pink handle., engineered with a static dissipative polymer and is packaged in an anti-static bag

SKU	HEAD WIDTH	HEAD THICKNESS	HEAD LENGTH	HANDLE WIDTH	HANDLE THICKNESS	HANDLE LENGTH	TOTAL SWAB LENGTH	PACKAGING
LTA03163.10	5.0mm	3.0mm	13.0mm	2.4mm	2.4mm	71.0mm	76.0mm	100 SWABS/PACK 10 PACKS/CASE

Foam swab with a short handle and rigid core for general purpose cleaning in confined areas with superior particle entrapment capability

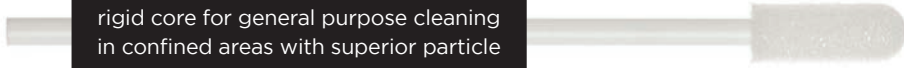

SKU	HEAD WIDTH	HEAD THICKNESS	HEAD LENGTH	HANDLE WIDTH	HANDLE THICKNESS	HANDLE LENGTH	TOTAL SWAB LENGTH	PACKAGING
LT000125.10	13.0mm	9.0mm	25.0mm	5.0mm	3.0mm	125.0mm	127.0mm	100 SWABS/PACK 10 PACKS/CASE

Foam swab with an absorbent large rectangular flat head provides a maximum surface area for cleaning broad flat surfaces



SKU	HEAD WIDTH	HEAD THICKNESS	HEAD LENGTH	HANDLE WIDTH	HANDLE THICKNESS	HANDLE LENGTH	TOTAL SWAB LENGTH	PACKAGING
LTO1465.10	7.0mm	3.0mm	16.8mm	3.1mm	3.1mm	145.0mm	162.0mm	100 SWABS/PACK 10 PACKS/CASE

Foam swab with a long handle for cleaning hard to reach areas with good sorbency and excellent solvent hold





**LAB-TIPS® CLOSED CELL (NON-RETICULATED) FOAM SWABS**  
**CLEANROOM LAUNDERED 100 PPI CLOSED CELL POLYURETHANE FOAM SWAB HEADS**

Closed Cell or non-reticulated foams are completely sealed with cell windows intact. Closed cell foams generally exhibit higher density, greater durability and reduced absorption versus open cell foams. Berkshire's closed cell foam swabs are manufactured from 100 ppi polyurethane.

SKU	HEAD WIDTH	HEAD THICKNESS	HEAD LENGTH	HANDLE WIDTH	HANDLE THICKNESS	HANDLE LENGTH	TOTAL SWAB LENGTH	PACKAGING
LTC125.5	13.0mm	8.0mm	25.0mm	5.5mm	2.8mm	100.0mm	125.0mm	100 SWABS/PACK 5 PACKS/CASE



Foam swab with a durable large rectangular head provide maximum surface area for cleaning broad flat surfaces

**LAB-TIPS® NONWOVEN 100% POLYESTER SWABS**  
**HYDROENTANGLED 100% POLYESTER SWAB HEADS**

Swabs made from 100% polyester nonwoven material are absorbent, non-abrasive and have very low ionic contamination and NVR levels. These swabs are also compatible with most solvents.

SKU	HEAD WIDTH	HEAD THICKNESS	HEAD LENGTH	HANDLE WIDTH	HANDLE THICKNESS	HANDLE LENGTH	TOTAL SWAB LENGTH	PACKAGING
LTN70F.20	4.0mm	2.0mm	11.0mm	2.2mm	2.2mm	59.0mm	70.0mm	100 SWABS/PACK 20 PACKS/CASE

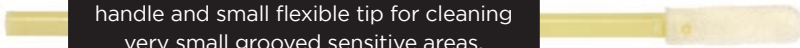

Nonwoven polyester swab with short handle and small flexible tip for cleaning very small grooved sensitive areas, soft and non-abrasive

SKU	HEAD WIDTH	HEAD THICKNESS	HEAD LENGTH	HANDLE WIDTH	HANDLE THICKNESS	HANDLE LENGTH	TOTAL SWAB LENGTH	PACKAGING
LTN1465.10	7.0mm	4.0mm	17.0mm	3.1mm	3.1mm	145.0mm	162.0mm	100 SWABS/PACK 10 PACKS/CASE

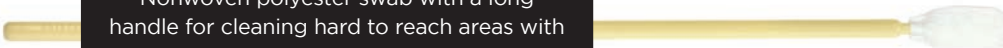

Nonwoven polyester swab with a long handle for cleaning hard to reach areas with good sorbency and excellent solvent hold

# SWAB/SOLVENT COMPATIBILITY CHART

SOLVENT	HEAD SUBSTRATE	
	FOAM	POLYESTER
ACETIC ACID	U	U
ACETONE	S	U
ACETONITRILE	U	U
AMMONIA, ANHYDROUS	U	U
ANILINE	S	U
BENZENE	S	U
CARBON TETRACHLORIDE	S	U
CHLOROFORM	S	U
CHLOROPHENOL	D	D
CHROMIC ACID	D	D
CYCLOHEXANE	S	U
DIMETHYLFORMAMIDE	D	S
DIMETHYLSULFOXIDE	D	S
ETHYL ACETATE	S	U
ETHYL ALCOHOL	U	U
ETHYL CHLORIDE	S	U
FORMIC ACID	D	U
HEXANE	U	U

SOLVENT	HEAD SUBSTRATE	
	FOAM	POLYESTER
HYDROCHLORIC ACID 48%	D	D
HYDROGEN PEROXIDE	D	U
ISOPROPYL ALCOHOL	U	U
METHANOL	S	U
METHYL ETHYL KETONE	S	U
METHYLENE CHLORIDE	S	U
NITRIC ACID 100%	D	D
NITROBENZENE	S	U
PERCHLOROETHYLENE	U	U
PHOSPHORIC ACID 85%	D	U
SODIUM HYDROXIDE 36%	S	U
SULFURIC ACID 98%	D	D
TOLUENE	S	U
TRICHLOROETHYLENE	S	U
VINYL ACETATE	S	U
WATER	U	U
XYLENE	S	U

**NOTE:**

**U** = UNAFFECTED, **S** = SWELLS, **D** = DEGRADES

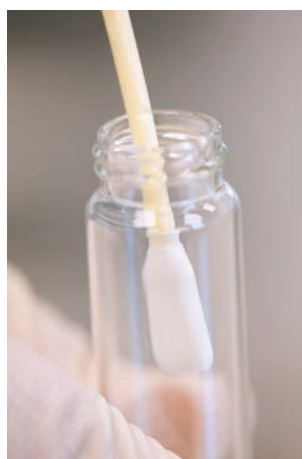
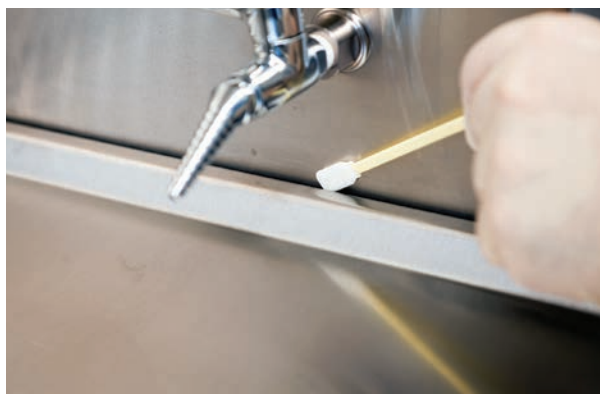

# BCR<sup>®</sup> MOP SELECTION GUIDE



	STRING	CHOICE <sup>®</sup>	DOUBLE SIDED	ERGONOMIC	FOLDING FLAT	BCR LARGE <sup>®</sup>	BCR <sup>®</sup> SMALL	EASYSKIN <sup>®</sup> 360
AUTOCLAVABLE	●	●	●	●	●	●	●	●
FLOORS	●	●	●	●	●	●	●	
WALLS			●	●	●	●	●	
CEILINGS			●	●	●	●	●	
RABS								●
ISOLATORS								●
CACI/CLASS II BSC								●
LARGE AREAS	●	●	●	●	●	●		
SMALL AREAS			●	●	●	●	●	●
UNDER EQUIPMENT			●	●	●	●	●	
WET CLEANING	●	●	●	●	●	●	●	●
DRY CLEANING			●	●	●	●	●	●
GLOVE BOXES								●

# BCR® CLEANROOM LOOPED STRING MOP SYSTEM

## Cleanroom Looped String Mop Heads

Looped-end-fan-tail construction to minimise particle generation

### BCR® Mop 1

Nonwoven polyester — Disposable

This is an absorbent, economical, unlaundered soft mop designed for both the easy removal of contamination from floors and for the distribution of disinfectants.

PRODUCT	SKU	MOP/PACK	MOPS/CASE
BCR® MOP 1	BCM.1.12	1	12



### BCR® Mop 4

100% knitted polyester — Relaunderable

Laundered and packaged in an ISO Class 4 cleanroom, this mop has low particulates and fibres. It has excellent chemical and abrasion resistance, with a lot number on each pack ensuring traceability. Available gamma irradiated.

PRODUCT	SKU	MOP/PACK	MOPS/CASE
BCR® MOP 4	BCM.4.12	1	12
BCR® MOP 4	BCM.4IR.12	1	12

## CLEANROOM STRING AND LOOP MOP HANDLE & CLAMP

### Handle: Features and Advantages

- Anodised aluminum handle
- Fixed length of 140cm
- Lightweight
- Easily connects to clamp
- Corrosion and chemical resistant
- Not Autoclavable

### Clamp: Features and Advantages

- Blue polypropylene mop clamp
- Latch-style swing-away bar for quick and easy mophead changes
- Easily connects to handle
- Autoclavable
- Corrosion and chemical resistant

PRODUCT	SKU	PACKAGING	MOPS/HANDLES/ CASE
CHOICE MOP HANDLE & CLAMP SET	CHMH.SET.1	1 HANDLE & 1 CLAMP	1

### DID YOU KNOW ?

Certificates of Irradiation are available 24/7 on [berkshire.uk.com](http://berkshire.uk.com) for BCM.4IR.12

## Cleanroom Looped String Mop Wringer, Cart and Buckets - Fully Autoclavable

### Composition and Technology

- The Cleanroom Cart is made of high quality stainless steel and is fully autoclavable
- Locking casters provide stability
- Wringer is made of durable plastic
- Ergonomically designed handle serves as a rest for the mop handle and makes the cart easy to manoeuvre in tight production areas
- Two 20 litre polypropylene buckets are colour coded grey and red to differentiate between clean and dirty solutions

*\*Internal bucket graduations help insure correct mixing of cleaning and disinfecting solutions*

PRODUCT	SKU	QTY PER CASE
STAINLESS STEEL MOP CART WITH BUCKETS	BCRMOPCART1	1
MOP WRINGER	BCRSTRWRINGER1	1



### HANDLE AND CLAMP ASSEMBLY INSTRUCTIONS



# EASYSYSTEM<sup>®</sup> 360 ISOLATOR CLEANING SYSTEM

## ISOLATOR CLEANING TOOL (ICT)



Efficient cleaning of compounding isolators, biological safety cabinets, laminar flow hoods and other mini-environments is critical to the quality and purity of compounded products. The EasyClean<sup>®</sup> 360° System includes a lightweight, manoeuvrable cleaning tool along with easy-to-use laundered polyester knit covers.

- Durable, mirror finish, stainless steel mop head swivels 360° for easy manoeuvrability
- Head can be locked for 180° swivel when desired
- 10x18cm triangular head shape allows improved access to tight corners.
- Lightweight anodised aluminum handles provided in 2 lengths - 35cm and 61cm
- Mop head and handles can be sterilised by autoclave or gamma irradiation



PRODUCT	SKU	HANDLE SIZES	QTY PER CASE
EASYSYSTEM <sup>®</sup> 360 ISOLATOR CLEANING TOOL	EC360.ICT.1	35cm & 61cm	1
TELESCOPING ALUMINUM HANDLE	BCR.T2HANDLE.1	95 – 180cm	1 (SOLD SEPARATELY)

## EASYSYSTEM<sup>®</sup> ELASTIC ICT COVERS



- Made from 100% continuous filament knitted polyester
- Laundered and packaged in an ISO Class 4 cleanroom
- Stretch fabric and elastic edge allow easy installation and secure fit
- Recommended for use with the EasyClean<sup>®</sup> 360 padded cover
- Autoclavable

PRODUCT	SKU	PACKAGING	PACKS/CASE
EASYSYSTEM <sup>®</sup> ELASTIC ICT COVERS	EC360.EC.6	25 ELASTIC COVERS & 1 PADDED COVER/PACK	6
STERILE EASYSYSTEM <sup>®</sup> ELASTIC ICT COVERS	EC360.ECST.20	10 ELASTIC COVERS & 1 PADDED COVER/PACK	20

## EASYSYSTEM<sup>®</sup> NONWOVEN ICT COVERS

- Double-ply 55% cellulose/45% polyester
- 100% nonwoven rayon inner layer for added absorbency
- Elastic edge allows secure fit on the mop head during use
- Autoclavable
- Recommended for use in an ISO Class 5 - 8 cleanroom or EU Grade B/C/D

PRODUCT	SKU	PACKAGING	PACKETS/CASE
EASYSYSTEM <sup>®</sup> ICT COVERS PACK	EC360.NW.40	5 NONWOVEN COVERS 4 PACKS/PACKET	10

Light weight anodised aluminum handles provided in 2 lengths — 35cm and 61cm

Head can be locked for 180° swivel when desired

Mop head and handles can be sterilised by autoclave or gamma irradiation

10x18cm triangular head shape allows improved access in tight corners

Durable, mirror finish, stainless steel mop head swivels 360° for easy manoeuvrability

\* Sterile Version

Gamma irradiated and sterile validated to a 10-6 Sterility Assurance Level per ANSI/AAMI/ISO guidelines. - EU Grade A/B/C/D

## EASYCLEAN® PADDED ICT COVERS

- 100% continuous filament knitted polyester padded covers are laundered and packaged in an ISO Class 4 cleanroom
- Recommended for use with the EasyClean elastic cover
- Foam-free cushioned design ensures even surface coverage with reduced residues and contaminants
- Autoclavable

PRODUCT	SKU	PADS/PACK	PACKETS/CASE
EASYCLEAN® 360 PADDED COVERS	EC360.PAD.6	25(BULK)	6
CHOICE® EASYCLEAN 360 COVERS	EC360CHP40	5	40
CHOICE® STERILE COVERS	EC360CHPST40	5	40
CHOICE® STERILE PRESATURATED	SSPEC360P40	5	40



# ERGONOMIC CLEANROOM FLAT MOP SYSTEM

The ergonomic Flat Mop holder is a versatile flat mop suitable for almost all application areas. Your cleanroom staff can attach mops faster and more efficiently than ever. Thanks to the cleanroom flat mops V shape, it slips smoothly into the pouches of the mop reducing bending and decreasing injury.

- Ergonomic working hand-switch opening of the holder and mop discarding while standing upright
- No touching of soiled mops when discarding
- Completely flat action for cleaning under and behind equipment

PRODUCT	SKU	SIZE	QTY PER CASE
V FLAT MOP HOLDER WITH CLIPS	BCRVSMOP10	10 X 40cm	10 V FLAT MOPS/20 CLIPS
V FLAT MOP HOLDER WITH CLIPS	BCRVSMOP1	10 X 40cm	1 V FLAT MOPS/2 CLIPS
TELESCOPING HANDLE	BCRHANDLE10	89-165cm	10
TELESCOPING HANDLE	BCRHANDLE1	89-165cm	1
V FLAT MOP CLIPS	BCRVSClip20	N/A	20

## CLEANROOM ERGONOMIC FLAT MOP COVERS

PRODUCT	SKU	SIZE	COVERS/PACK	PACKS/CASE
V MOP NONWOVEN COVER	FMC4NW20	11 X 38cm	10	20
V MOP FOAM COVER	FMC6LF12	11 X 38cm	10	20
V MOP MICRODENIER COVER	FMC8MD10	45 X 15cm	6	10
IR V MOP MICRODENIER COVER	FMC8MD10IR	45 X 15cm	6	10

## Wringer, Sieve, Cart And Buckets

PRODUCT	SKU	QTY PER CASE	PACKS/CASE
STAINLESS STEEL MOP CART WITH BUCKETS - 2.20 LITRE BUCKETS , BLUE, RED	BCRMOPCART1	1	1
STAINLESS STEEL V FLAT MOP WRINGER	BCRVSWRINGER1	1	1
STAINLESS STEEL V FLAT MOP SIEVE	BCRFMSIEVE1	1	1

## Autoclavable Mop Wipers

PRODUCT	SKU	SIZE	COVERS/PACK	PACKS/CASE
DURX® 670	DR670101810	25 X 45cm	100	10
MICROSEAL®-VP	MSVP1018B10	25 X 45cm	50 (BULK)	10
MICROSEAL SUPERSORB® LITE	SSLT1018B10	25 X 45cm	25 (BULK)	10
MICROPOLX® 2750	MPX2750101810	25 X 45cm	50	10



Detachable wiper clips allow the use of disposable mop wipers, but are not autoclavable

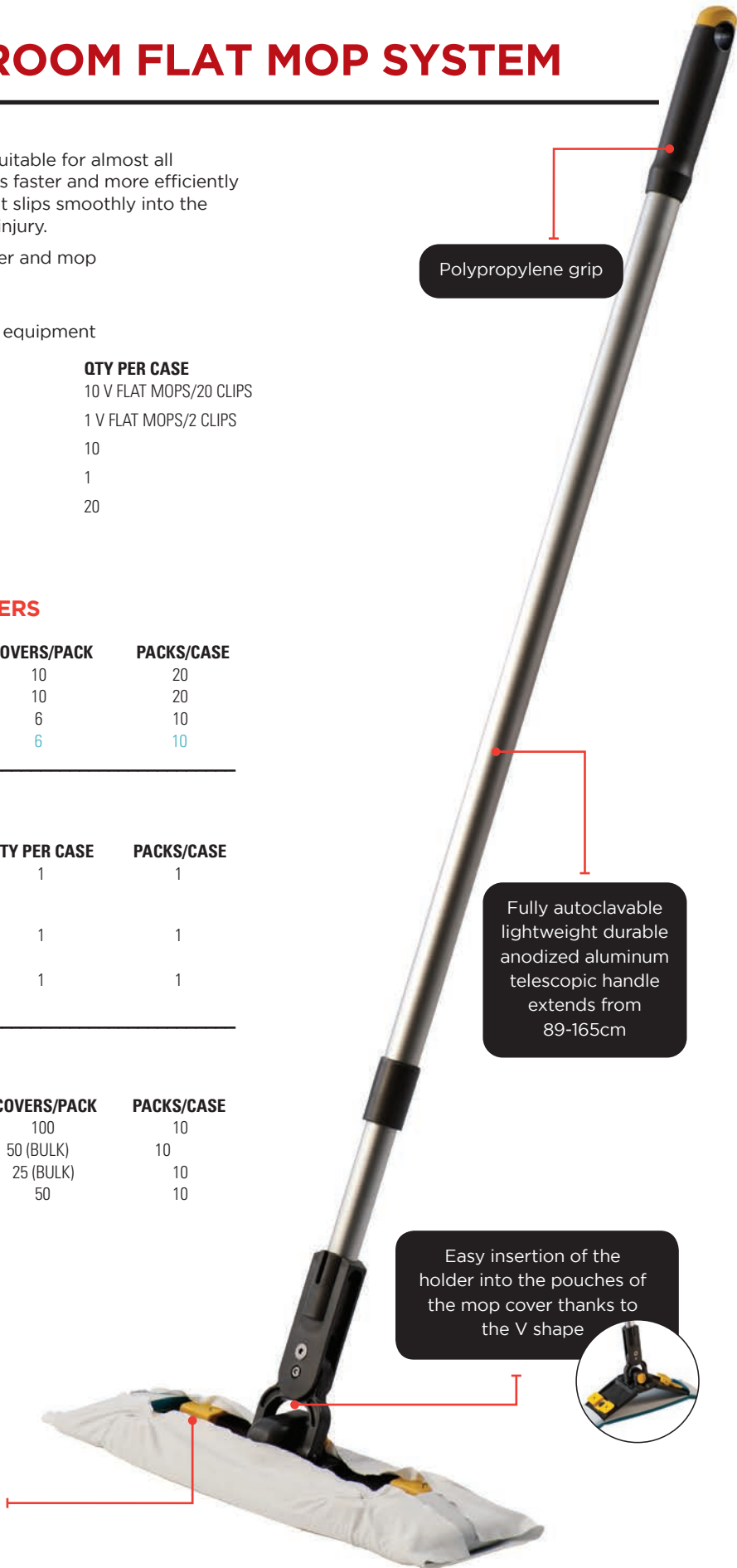

Polypropylene grip

Fully autoclavable lightweight durable anodized aluminum telescopic handle extends from 89-165cm

Easy insertion of the holder into the pouches of the mop cover thanks to the V shape



## ERGONOMIC FLAT MOP WRINGER, SIEVE, CART AND BUCKETS

### Composition and Technology

- The Cleanroom Mop Cart is made of high quality stainless steel and is fully autoclavable.
- Locking casters provide stability during use.
- Wringer is made of high quality stainless steel.
- Ergonomically designed handle serves as a rest for the mop handle and makes the cart easy to manoeuvre in tight production areas.
- Two 20 litre polypropylene buckets are colour coded grey and red to differentiate between clean and dirty solutions.
- Internal bucket graduations help ensure correct mixing of cleaning and disinfecting solutions

PRODUCT	SKU	QTY PER CS	PKS/CS
STAINLESS STEEL MOP CART WITH BUCKETS — 2, 20 LITRE BUCKETS, GREY, RED	BCRMOPCART1	1	1
STAINLESS STEEL V FLAT MOP WRINGER	BCRVSWRINGER1	1	1
STAINLESS STEEL V FLAT MOP SIEVE	BCRFMSIEVE1	1	1



## AUTOCLAVABLE CLEANROOM MOP WIPERS

### Durx® 670

Nonwoven, 55% cellulose/45% polyester

SKU	SIZE	SHEETS/PACK	PACKS/CASE
DR670101810	25 X 46cm	100	10

### MicroSeal®-VP

Sealed edge, 100% knitted polyester, laundered

MSVP1018B10	25 X 46cm	50 (BULK)	10
-------------	-----------	-----------	----

### MicroSeal SuperSorb® Lite

Sealed edge, 2-ply, 100% knitted polyester, laundered

SSLT1018B10	25 X 46cm	25 (BULK)	10
-------------	-----------	-----------	----

### MicroPolx® 2750

Polyester/nylon, microfibre knitted

MPX2705101810	25 X 46cm	50	10
---------------	-----------	----	----



## CLEANROOM DOUBLE SIDED FLAT MOP COVERS



### Double Sided Mop Nonwoven Cover

- 68 gsm polyester/cellulose outer cover
- 100% rayon nonwoven inner layer provides superior absorbency
- High tear strength
- Each cover is individually wrapped
- Autoclavable

SKU	SIZE	COVERS/ PACK	PACKS/ CASE
FMC5NW24	25 X 46cm	4	24



### Double Sided Mop Foam Cover

- Abrasion resistant polyester knit cleanroom fabric laminated to absorbent polyurethane foam
- Laser cut and cleanroom laundered to minimise fibre and particle release
- High absorbency capacity
- 5mm thickness provides cushioned surface for optimum conformance to uneven floors, walls and ceilings
- Each cover is individually wrapped
- Autoclavable

SKU	SIZE	COVERS/ PACK	PACKS/ CASE
FMC7LF20	25 X 46cm	4	20

## DOUBLE SIDED CLEANROOM FLAT MOPPING SYSTEM

The Double Sided Flat Mop holder's unique design allows operators to clean approximately twice the surface area of a conventional flat mop before changing or re-saturating the mop head, improving cleaning efficiency and reducing cleaning time.



### CLEANROOM DOUBLE SIDED FLAT MOP HOLDER

- Attachment and removal of the mop covers without bending
- Extremely manoeuvrable with a 360° swiveling head and flat profile-ideal for cleaning under and around production equipment
- Durable, autoclavable plastic
- Double the surface coverage of conventional flat mopping systems
- Edge mounted handle design perfect for cleaning baseboards



### CLEANROOM FLAT MOP TELESCOPING HANDLE

- Durable anodised aluminum with polypropylene grip
- Fully autoclavable, polypropylene grip, lightweight durable anodised aluminum telescopic handle extends from 89-165cm

PRODUCT	SKU	SIZE	QTY PER CASE
DOUBLE SIDED MOP HOLDER	BCRDSTMOP10	10 X 40cm	10
DOUBLE SIDED MOP HOLDER	BCRDSTMOP1	10 X 40cm	1
TELESCOPING HANDLE	BCRHANDLE10	89-165cm	10
TELESCOPING HANDLE	BCRHANDLE1	89-165cm	1

## CLEANROOM DOUBLE SIDED FLAT MOP WRINGER CART AND BUCKETS - FULLY AUTOCLAVABLE

### Composition and Technology

- The Cleanroom Mop Cart is made of high quality stainless steel
- Locking casters provide stability
- Wringer is made of durable plastic
- Ergonomically designed handle serves as a rest for the mop handle and makes the cart easy to maneuver in tight production areas
- Two 20 litre polypropylene buckets are colour coded grey and red to differentiate between clean and dirty solutions
- Internal bucket graduations help insure correct mixing of cleaning and disinfecting solutions



PRODUCT	SKU	QTY PER CASE
STAINLESS STEEL MOP CART WITH BUCKETS	BCRMOPCART1	1
DS FLAT MOP WRINGER	BCRDSWRINGER1	1



## BCR® FOLDING FLAT POCKET MOP HEAD

- Autoclavable
- Clean, lightweight and durable
- Ideal for cleaning walls and ceilings

PRODUCT	SKU	ATTACHMENT	SIZE	QUANTITY
FOLDING FLAT MOP HEAD	FFM10	CLICK TO LOCK	10X40cm	10 PER CASE
TELESCOPIC HANDLE	HANDLEFMTELE180	CLICK TO LOCK	95-180cm	10 PER CASE

## BCR® FOLDING FLAT MOP COVER

- 100% knitted polyester outer cover
- 100% rayon nonwoven inner layer
- High tear strength

PRODUCT	SKU	SIZE	COVERS/PACK	PACKS/CASE
FOLDING FLAT MOP COVER 2	FMC210	13X39cm	10X40cm	10 PER CASE

## BCR® FOLDING FLAT MOP COVER - GAMMA IRRADIATED

- 68 gsm polyester/cellulose outer cover
- 100% rayon nonwoven inner layer
- Gamma irradiated - certificates of irradiation with each case

PRODUCT	SKU	SIZE	COVERS/PACK	PACKS/CASE
FOLDING FLAT MOP COVER 1 IR	FMC1IR10	13X40cm	20	10

## BCR® FLAT MOP SYSTEM Flat Mop Head Frame

Efficient cleaning of floors, wall and other large surfaces is critical to the overall cleanliness of the production environment. BCR® Flat Mop Systems replicate the most effective way to clean a surface - WIPING. Available with a range of wiping substrates to support your level of cleanliness.

### Features

- Clean, light and durable
- High quality anodised aluminum
- Autoclavable
- Unique stainless steel spring mechanisms for wiper attachment (Mop 2)
- Plastic eyes for wiper attachment (Mop 3 and 4)

PRODUCT	SKU	SIZE	QUANTITY
BCR® LARGE MOP HEAD FRAME W/SPRINGS	BCR.MOP2.1	9 X 58cm	1 PER CASE
BCR® LARGE MOP HEAD FRAME W/SPRINGS	BCR.MOP2.10	9 X 58cm	10 PER CASE
BCR® SMALL MOP HEAD FRAME W/PLASTIC EYES	BCR.MOP3.1	9 X 28cm	1 PER CASE
BCR® SMALL MOP HEAD FRAME W/PLASTIC EYES	BCR.MOP3.10	9 X 28cm	10 PER CASE
BCR® LARGE MOP HEAD FRAME W/PLASTIC EYES	BCR.MOP4.1	9 X 58cm	1 PER CASE
BCR® LARGE MOP HEAD FRAME W/PLASTIC EYES	BCR.MOP4.10	9 X 58cm	10 PER CASE

## Flat Mop Handle

### Features

- Telescopic handle: extends from 95-180cm
- Anodised aluminum; lightweight and strong
- Autoclavable

PRODUCT	SKU	SIZE	QUANTITY
TELESCOPING ALUMINUM HANDLE	BCR.T2HANDLE.1	95-180cm	1 PER CASE
TELESCOPING ALUMINUM HANDLE	BCR.T2HANDLE.10	95-180cm	10 PER CASE



FOLDING  
FLAT MOP

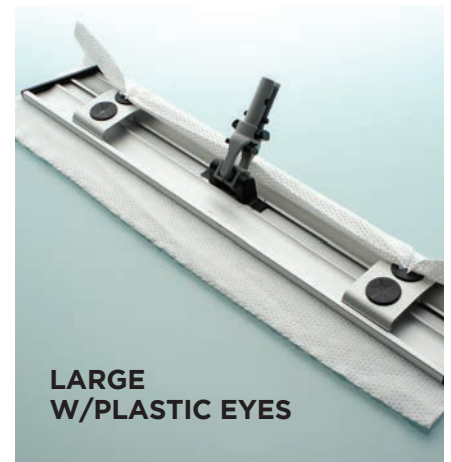

LARGE  
W/PLASTIC EYES



SMALL  
W/PLASTIC EYES

## BCR® CLEANROOM FLAT MOP WIPERS

All the wipers are disposable and measured to fit the Mop Head Frame. More than one wiper can be attached to the mop head at a time. After mopping the area, the outer wiper can be disposed of and the remaining wipers are ready for the next mopping phase. This guarantees a fresh wiper is used for each new phase.



### MicroSeal SuperSorb® Flat Mop Wiper

- Two-ply bonded, sealed edge 100% polyester
- Laundered and packaged in an ISO Class 4 (Class 10) cleanroom
- High Abrasion Resistance
- Autoclavable/sterile version available
- Lot number of each pack for traceability

SKU	SIZE	SHEETS/ PACK	PACKS/ CASE
MSSS.0812.12	20 X 30cm	50	12
MSSS.0824.12	20 X 61cm	25	12



### Choice® SuperSorb Mop Wiper

- Two-ply bonded, sealed edge 100% polyester
- Laundered and packaged in an ISO Class 4 (Class 10) cleanroom
- High Abrasion Resistance
- Economical
- Lot number of each pack for traceability

SKU	SIZE	SHEETS/ PACK	PACKS/ CASE
CHSS0824B12	20X61cm	25 (BULK)	12



### Durx® 670 Flat Mop Wiper

- Hydroentangled 55% cellulose/45% polyester
- Smooth, highly sorbent and durable
- Autoclavable/sterile versions available
- No binders or chemical additives
- Critical combination of the strength of synthetic polyester with the absorbency of cellulose
- Lot number of each pack for traceability

SKU	SIZE	SHEETS/ PACK	PACKS/ CASE
DR670081220	20 X 30cm	100	20
DR670082410	20 X 61cm	100	10
DR670230920	23 X 53cm	100	20

### SatPax® 670 Flat Mop Wipe

- Hydroentangled 55% cellulose/45% polyester
- 70% IPA/30% DI H2O (60% saturation) and 50% IPA/50% DI H2O (70% saturation)
- Smooth and durable with good wet strength
- Lot number of each pack for traceability

SKU	SIZE	SHEETS/ PACK	PACKS/ CASE	IPA/ DI
SPX670230912	23 X 58cm	25	12	70/30
SPX67000312	23 X 60cm	25	12	50/50

### Super Polx® 1200A Flat Mop Wiper

- 100% continuous filament double knitted polyester
- Laundered and packaged in an ISO Class 4 (Class 10) cleanroom
- Sterilisable by autoclave, gamma or beta
- Low particles, fibres, ions and non-volatile residues
- Lot number of each pack for traceability

SKU	SIZE	SHEETS/ PACK	PACKS/ CASE
S1200A23095	23X58cm	150	5
S1200A230530	58X12cm	50	30

# BCR<sup>®</sup> AND CHOICE<sup>®</sup> CLEANROOM SOCKS

## BCR<sup>®</sup> Cleanroom Socks

96% microdenier nylon and 4% lycra

BCR<sup>®</sup> Cleanroom socks provide the next level of cleanroom foot health and operator comfort. The microdenier technology provides the sock with superior cool feeling and comfort.

### Technical Data

DESCRIPTION	AVERAGE DATA	TEST METHOD
Common Everyday Sock	44607	0.5 µm Helmke Drum: Particles ≥ 0.5 µm/ft <sup>3</sup>
Bershire BCR <sup>®</sup> Sock	22	0.5 µm Helmke Drum: Particles ≥ 0.5 µm/ft <sup>3</sup>

<b>PRODUCT</b> BCR <sup>®</sup> CLEANROOM SOCK	<b>NUMBER</b> BCRSOCKR24	<b>SIZE</b> ONE-SIZE-FITS-ALL	<b>PRS/PK</b> 6	<b>PKS/CS</b> 24	<b>STYLE PACKED</b> STACKED
---	-----------------------------	----------------------------------	--------------------	---------------------	--------------------------------

### Advantages

- Extremely soft and comfortable - autoclavable
- Advanced technology for extreme moisture management
- Reduced odour caused by foot perspiration after extended wear
- Meets requirements for EU GMP Annex 1 Section 7.15
- Autoclavable (121° C, 30 minutes)



## Choice<sup>®</sup> Cleanroom Socks

99% continuous filament polyester/1% spandex

### Technical Data

DESCRIPTION	AVERAGE DATA	TEST METHOD
Polyester Cotton Sports Sock	45,000	0.5 µm Helmke Drum: Particles ≥ 0.5 µm/ft <sup>3</sup>
Choice Cleanroom Sock	120	0.5 µm Helmke Drum: Particles ≥ 0.5 µm/ft <sup>3</sup>

<b>PRODUCT</b> CHOICE <sup>®</sup> CLEANROOM SOCK	<b>NUMBER</b> CHSOCKR1050	<b>SIZE</b> ONE-SIZE-FITS-ALL	<b>PRS/PK</b> 10	<b>PKS/CS</b> 50	<b>STYLE PACKED</b> STACKED
--	------------------------------	----------------------------------	---------------------	---------------------	--------------------------------

### Advantages

- Mid-calf length with elastic cuff for secure fit
- Soft and comfortable
- Laundered and packaged in a Class 5 cleanroom
- Meets the requirements of EU GMP Annex 1 section 7.15
- Autoclavable (121° C, 30 minutes)



# CLEANING CLEANROOM SURFACES USING A DOUBLE BUCKET SYSTEM

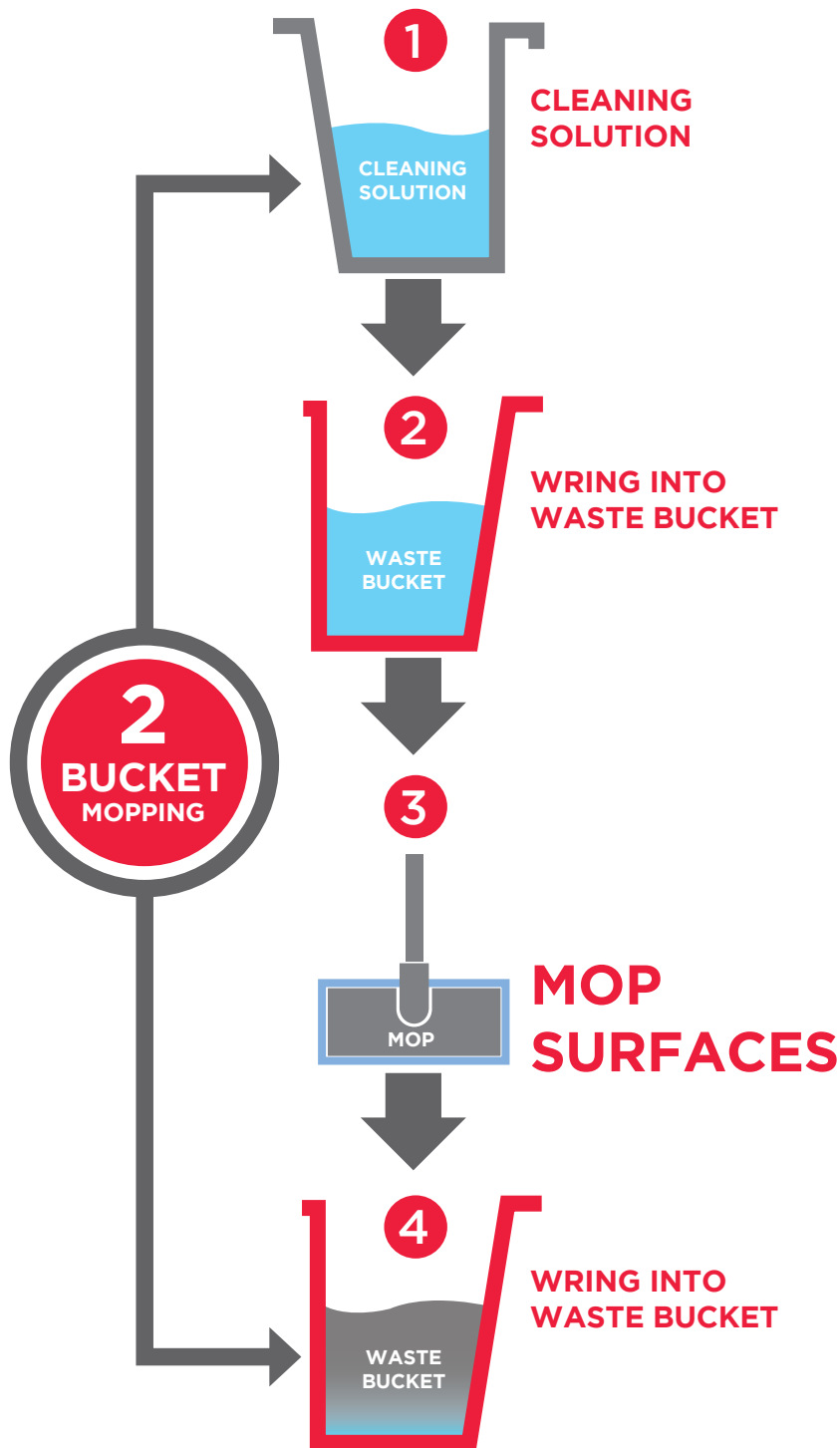

## DOUBLE BUCKET SYSTEM

- 1. Cleaning Solution Bucket** - Add or mix the cleaning solution to the first bucket and fully saturate the mop cover in the solution.
- 2. Waste Bucket** - Using the wringer, located over the waste bucket, wring the excess cleaning solution from the mop into the waste bucket - the second bucket.
- 3. Mop** - Apply the cleaning solution to the surface using your company's Standard Operating Procedure (SOP) for mopping.
- 4. Waste Bucket** - Using the wringer, wring the mop and waste water into the waste bucket for the second time. This process can be repeated multiple times until your surfaces are cleaned. \*



\* The cleaning solution and mop cover should be changed when they are visibly dirty or show evidence of debris.

# Proper Wiper Folding & Surface Cleaning

A guide to properly fold and use a low-linting wiper for maximum efficiency and effectiveness in a controlled environment.

## Recommended Surface Wiping Procedures

- A.** Prior to entering the cleanroom, follow written SOPs for proper hand hygiene, garment donning, and gloving procedures.
- B.** Disinfect and clean using proper wiping technique.
- C.** Quarter-fold the wiper to get the maximum use out of the wiper and to prevent recontamination. Turn to a new wiper surface after each straight stroke.
- D.** Always wipe using overlapping strokes, in a parallel direction. Use a **new wiper surface** with each linear stroke and always wipe from back to front, **cleanest to dirtiest** and **driest to wettest**.
- E.** Never wipe in a circular motion.



- (1)** Hold the wiper in mid-air. Take the wiper by its edges and fold in half. The wiper should not be placed on any surface during the folding action.



- (2)** Fold the wiper in half again, creating four cleaning faces: two outside and two inside



- (3)** Work from the cleanest areas to the dirtiest areas in long, overlapping unidirectional strokes. Each face of the wiper will be used for one straight stroke. Turn the wiper over and make a second stroke.



- (4)** Refold the wiper as shown in Step 2 to enclose the two contaminated faces and expose the two clean faces. Repeat Step 3 using the two clean faces.



- (5)** Wiper may be completely unfolded, reversed, and refolded beginning again at Step 1 to enclose the four contaminated faces and expose the four remaining clean faces.

Classification numbers (N)	Maximum concentration limits (particles / m <sup>3</sup> ) for particles equal to and larger than the sizes listed below						Cleanroom Rules:
	0.1 Micron (µm)	0.2 Micron (µm)	0.3 Micron (µm)	0.5 Micron (µm)	1 Micron (µm)	5 Micron (µm)	
ISO 1	10	2					<ul style="list-style-type: none"> <li>• Always follow written SOPs</li> <li>• Remove watches, jewelry, nail polish and cosmetics</li> <li>• Don't eat, chew gum, or drink</li> <li>• Do not sit or lean on any work surface or equipment</li> <li>• Work with calm and slow movements</li> </ul>
ISO 2	100	24	10	4			
ISO 3	1,000	237	102	35	8		
ISO 4	10,000	2,370	1,020	352	83		
ISO 5	100,000	23,700	10,200	3,520	832	29	
ISO 6	1,000,000	237,000	102,000	35,200	8,320	293	
ISO 7				352,000	83,200	2,930	
ISO 8				3,520,000	832,000	29,300	
ISO 9				35,520,000	8,320,000	293,000	

### Contamination Fundamentals

#### Sources of Contamination

- Personnel
- Processes
- Objects
- Tools
- Fluids
- Equipment

- Skin particles
- Fibres

- Dust
- Grease

- Bacteria
- Viruses

- Metals
- Fungi

- Nonvolatile Residues
- Ions

**Berkshire**  
ENGINEERED CLEAN

[www.berkshire.uk.com](http://www.berkshire.uk.com)





CONTAMINATION CONTROL PRODUCT CATALOGUE